

AVTS

Advanced Visual Test Software

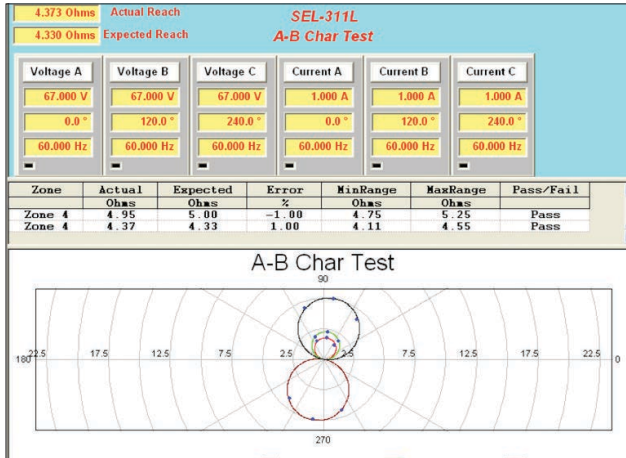

- **Powerful, easy-to-use Microsoft Windows XP/Vista®/7/8 compatible**
- **Designed to manage all aspects of protective relay testing for NERC reporting**
- **Now loaded with more features and capabilities:**
 - **Click-on-Fault**
 - **Dynamic Control with End-to-End test capability**
 - **Binary Search**
 - **Waveform Recorder with COMTRADE Playback with End-to-End test compatability**
 - **SSI File Reader**
 - **One-Touch Test™ with automatic download of setting using VB script or Modbus Communications**
- **Optional IEC 61850 test capability**

DESCRIPTION

AVTS is a Microsoft® Windows® XP®/Vista®/7 software program designed to manage all aspects of protective relay testing using the new Megger SMRT or MPRT relay test sets. More flexibility has been added as well as some new and powerful features.

AVTS comes in three different levels:

- **Basic**
- **Advanced**
- **Professional**

Every SMRT or MPRT unit comes with AVTS Basic.

The **Basic** version includes Online Vector, Ramp and Click-On-Fault controls with the ability to import, save and execute test modules. In addition, the Basic version includes capability to control 9 voltages and 9 currents (3 SMRT36 interconnected units) simultaneously.

The **Advanced** version includes the Test Editor, Dynamic Control, SS1 Converter, End-to-End test macros and basic programming Tools for creating and editing test modules.

The **Professional** version includes all of the features of the Basic and Advanced versions plus some new and powerful features. It includes the DFR Waveform Viewer, One-Touch Test, Modbus, and Waveform Digitizer.

APPLICATIONS

Using the Online Ramp Control, traditional steady-state tests are easily performed with AVTS by simply applying test quantities to the device under test and automatically ramping the current, voltage, phase angle or frequency.

Using either the Online Ramp, Vector or Dynamic Controls, Dynamic tests can easily be performed. The dynamic test includes setting a prefault condition and allowing the software to automatically test/search for the operating characteristic of the relay by selecting one of several available methods. Using Test Wizards or Test Modules, fault types are selected from a pull-down window.

Operating characteristics for virtually any type of relay are easily defined using Mho circles, Lenticular, Tomato characteristics, or a combination of lines, line and slope, time and amplitude, calculated value or theoretical object (a time-current curve may be scanned into the program using the digitizer feature in either the Advanced or Professional versions of AVTS).

The AVTS Test Screen enables the user to view test values (both theoretical and actual) on one screen. For example, the figure above shows test values, both theoretical and actual results, all on one screen.

The following chart provides an easy reference showing the features of each version of AVTS Software.

AVTS		Basic	Advanced	Professional
Feature	Description			
Online Vector Control	The Online Vector Control allows the user to have direct control of the Relay Test System. Up to sixteen vector states may be created and sequenced back through the test system. Now includes simultaneous control of up to 9 voltages and 9 currents (3 SMRT36 units interconnected).	■	■	■
Online Ramp Control	Preramp (prefault), Ramp 1 and Ramp 2 are available for use to be played back through the test system. Automatically Ramp or Pulse Ramp outputs. PulseRamp provides the capability to determine reach points on multi-zone distance relays without having to defeat the zone timing elements, and provides pre-fault load conditions for relays that require it. Enable timer control with either ramp. Simultaneous control of up to 9 voltages and 9 currents (3 SMRT36 units interconnected).	■	■	■
On-Line Click On Fault	The user can define the type of operating characteristic using the AVTS Theoretical Control or Import files in the RIO file format, then click at a point on the characteristic that they wish to test for, either as a Shot, or using the Search features. If using the Search the test will progress down a user defined test line, either as a ramp or a pulse ramp looking for the relay to operate. Test results appear in the RX diagram along with the theoretical operating characteristic of the relay.	■	■	■
RIO File Format	RIO file import allows the user to import an existing RIO file into the click-on-fault R/X diagram ready to proceed with the test.	■	■	■
DFR Playback	Import and execute relay test modules, which contain DFR playback files created using the DFR Waveform Viewer Tool.	■	■	■
Fault Calculator	Calculate fault values for \emptyset - \emptyset , \emptyset -N, and 3 \emptyset faults. Use line voltage, line Z and angle, relay volts and angle, relay amps and Z0/Z1.	■	■	■
Import, Save, and Execute Test Modules	Import relay test files and execute selected tests. Save results to built-in Microsoft Access compatible data base, and print results.	■	■	■
Overcurrent Wizard	Provides automatic testing of overcurrent relays, including pickup, timing characteristic using IEEE/IEC formulas or actual manufacturers time curves, Instantaneous, DC target and seal-in tests.	■	■	■
Over/Under Voltage Wizard	Provides automatic testing of over and under voltage relays, including pickup, timing characteristic and DC target and seal-in tests.	■	■	■
Distance Wizard	Provides automatic testing of distance relays. \emptyset - \emptyset , \emptyset -G, and 3 Phase faults are available. Test result graphics are displayed in an R X plane.	■	■	■
Differential Wizard	Provides automatic testing current differential relays, including pickup, slope (includes capability to control up to 8 currents for differential characteristic), and 2nd, 3rd and 5th harmonic restraint tests on transformer differential relays.	■	■	■
Directional Wizard	Provides automatic testing capability of directional elements.	■	■	■
Frequency Wizard	Provides automatic testing of under/over frequency relays, including pickup and timing.	■	■	■

		Basic	Advanced	Professional
Feature	Description			
Transducer Testing	AVTS users may create a test for any type transducer using the Test Editor Screen and the Analog Input control tool.	1	■	■
Test Editor	Provides editing tools for modifying tests.	2	■	■
Dynamic Control – Multi-State Playback – End-To-End Tests	Accessed through the Test Editor Screen, the Dynamic Control provides dynamic multi-state testing of relays with more flexibility and choices than Vector Control. A “state” can be voltage(s), current(s), phase angle(s), timers, start and stop the analog recorder, set Boolean logic for the binary inputs, set binary output(s), or even use variables to set values. The test transitions from one state to another after a programmed time delay of either milliseconds or cycles, or for End-to-End tests after a trigger condition. Allows the user to easily build harmonic waveforms with frequencies up to 1000 Hz.	3	■	■
Recorder	In association with the Dynamic Control is a Recorder feature, which not only records the action of the binary inputs and outputs, but it also records the actual analogue waveforms of the SMRT/MPRT voltage and current outputs. Use this new feature to capture and verify analogue output values. Use to monitor Binary Inputs and Outputs to capture and troubleshoot single-pole or three-pole coordination or suspected contact bounce situations. Use to capture multi-state playback to evaluate complex reclosing schemes. It will even record complex waveforms generated by the SMRT/MPRT, which could be used for harmonic evaluations.		■	■
Basic Programming Tool	Provides control tool in the Test Editor. Basic programs can be written using the test system command set for special testing applications.		■	■
SS1 File Converter	SS1 files are generated using Power System Simulation software programs by Electrocon® CAPE™ or Aspen One-liner® . By modeling the power system and using the SS1 files, the relay can then be tested dynamically using realistic system test scenarios.		■	■
Waveform Digitizer	Provides digitizing tools to create digital time curves for old electromechanical relay time curves (that do not fit any time curve algorithm) up to the most complex relay operating characteristics. Good for digitizing scanned waveforms (like from a light-beam chart recorder).			■
DFR Waveform Viewer and Playback	Import, view, modify and replay Digital Fault Recordings or EMTP/ATP simulations that are in the COMTRADE file format. Perform End-to-End tests playing COMTRADE waveforms when triggered by GPS clocks.			■
One-Touch	Test Editor control tool, used in conjunction with specific Megger Test Modules, to download relay settings (into the AVTS settings screen) from microprocessor based relays for full automatic one-touch testing. Used with VB script to auto test SEL relays and new MODBUS to auto test GE UR and selected Multilin relays.	4	4	4
Import Aspen Relay Database®	Capability to import relay settings directly from Aspen Relay Database®			

¹ Standard transducer test modules are provided for Voltage/Current/Watt/VAR and Frequency Transducers in the Library files. For special transducers, editing functions are available using Advanced or Professional versions.

² Limited functions to edit properties within the Test Editor window.

³ End-to-End test module available in Basic Relay Library.

⁴ One-Touch test modules available in Relay Library.

AVTS BASIC VERSION

There are three versions of AVTS software. **The Basic version is included with each SMRT/MPRT unit.** The Advanced and Professional versions are optional. In addition, the optional Megger GOOSE Configurator may be used with any version of AVTS to conduct automatic tests on IEC 61850 relays. The Basic version includes online Vector, Ramp and Click-On-Fault controls, relay testing wizards for most types of relays, the ability to import, save and execute relay specific test modules created either by Megger or someone else with either an Advanced or Professional version of AVTS 4.1. Basic can also playback a DFR file created using the Professional version of AVTS. The following describes the features of the Basic version of AVTS 4.1.

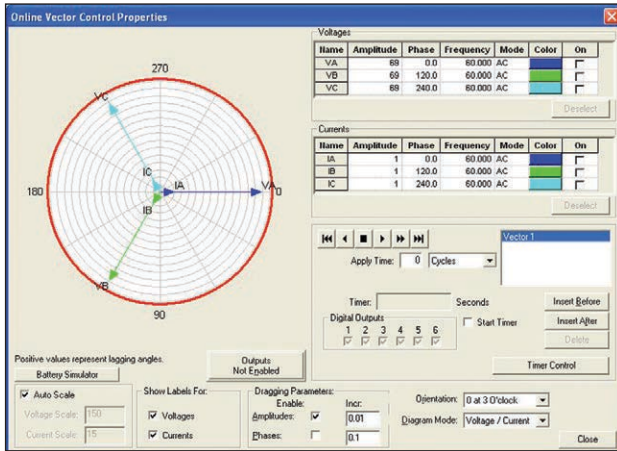

Online Vector Control

Online Vector Control

The **Online Vector Control**, launched from the AVTS Tools menu item, allows the user to have direct control of the Relay Test System. With 3 SMRT36 units interconnected provides control of up to **9 voltages and 9 currents simultaneously**. Up to **sixteen vector states** may be created and played back through the Relay Test System. A **timer control** is available to enable starting the Relay Test System timer at the execution of any one of the vector states. The timer stop is typically controlled by an action from one of a device's outputs connected to the appropriate Relay Test System timer stop gate. The default view of the Online Vector Control remains visible during all use of the control.

For **manual setting** of amplitudes and phases, a **gang control** is available through the selection of the vectors (Relay Test System amplifiers) to be controlled. The vectors to be controlled in gang are selected by using the mouse to grab and alter the vector(s) parameters. Vector selection is made by clicking on a vector channel name to highlight that vector with its parameters. Should it be desired to simultaneously control more than one vector, the user will need to click on the wanted vectors while holding the keyboard Ctrl key down to highlight all of the selected vectors (up to 9 voltages or currents with 3 SMRT36 units). The user may then select from the **'Dragging Parameters'** box whether the amplitudes and/or phases of the selected vectors are to be active. Once selected, the user can grab the tip of any of the selected vectors in the polar graph and, while holding the left mouse button down, move the vector(s). The values of the vector(s) will change

graphically and numerically, and simultaneously pass the new values directly to the corresponding Relay Test System amplifiers. Some other unique features are:

Aux Contact Check Box- will close an "aux" binary output contact conditional with change from one vector state to another.

Edit Custom Prefix Command- available for each vector state and allows entry of a formula, Relay Test System syntax, or other controlling variable for that selected vector state.

Zoom- enlarges the polar vector diagram to the full dimensions of the dialog box.

Favorites - save a single vector, or a set of multiple vectors, with all the parameters to a desired name for recall at a later time in the Online Vector Control (Basic Version) or the Test Editor Vector Control (requires Advanced version). Save to the name placed in the edit field will retain only the selected vector(s) in the vector list. The Edit Customs Prefix Commands are saved along with the generator parameters.

Set to Variables - selection replaces the numeric values for all the vector parameters to known default variable names. This function is more commonly used for the Vector Control used within a test development in the Test Editor (Advanced Version), where the variable names are given values in the Settings Screen, Variable Watch edit field (a powerful programming tool in the Advanced version) in the Test Screen, or in another control in the Test Editor (Advanced version) Screen prior to the Vector control.

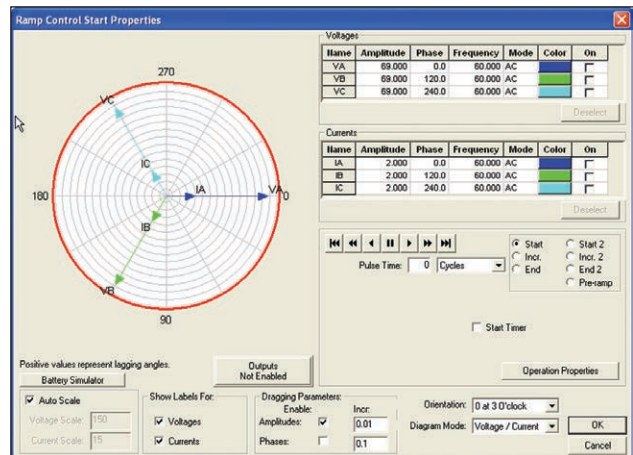

Online Ramp Control

Online Ramp Control

The **Online Ramp Control**, launched from the AVTS Tools menu item, allows the user to have direct real time control of the Relay Test System. This control is very similar to the Online Vector Control. However, where the vector control sequences through up to 16 different states, the Ramp Control provides automatic ramping of selected outputs to do pick-up or drop outs tests of amplitude, phase angle or frequency. Pre-ramp, Ramp 1 and Ramp 2 are available for use to be played back through the Relay Test System. With 3 SMRT36 units interconnected provides control of up to **9 voltages and 9 currents simultaneously**. A timer control is available to enable starting the Relay Test System timer at the execution of either of the ramp states. The timer stop is typically controlled by an action from one of a device's outputs connected to the timer stop gate.

Similar to Online Vector Control, Online Ramp Control provides manual ramping of amplitudes and/or phases. The gang control is similar through the selection of the vectors (Relay Test System amplifiers) to be controlled. The outputs to be controlled in gang are selected by using the mouse to grab and alter the parameters (see Online Vector Control for more details). Another feature of the Online Ramp Control is the ability to do Pulse Ramping. One advantage of Pulse Ramping is the capability to determine reach points on multi-zone distance relays without needing the defeat the zone timing elements.

For relays which require a pre-fault load condition prior to applying a fault value, the Online Ramp Control has a Pre-ramp (Pre-fault) state. This feature allows the user to apply the appropriate load values before Pulse Ramping begins. After applying a fault value the Ramp Control returns to the Pre-ramp state before the next value is applied. Many of the same features in the Online Vector Control are also available in the Ramp Control, such as the **Zoom, Set Variables** and **Favorites**.

Fault Calculator

The Fault Calculator allows the user to automatically calculate fault quantities for phase-to-phase, phase-to-ground and three-phase faults. The user inputs variables for: line voltage, line Z with angle, relay volts with angle, relay amps and compensation factors K0 or Z0/Z1 ratio. The compensation factor is applied to both the source Z and the line Z for all faults which include ground.

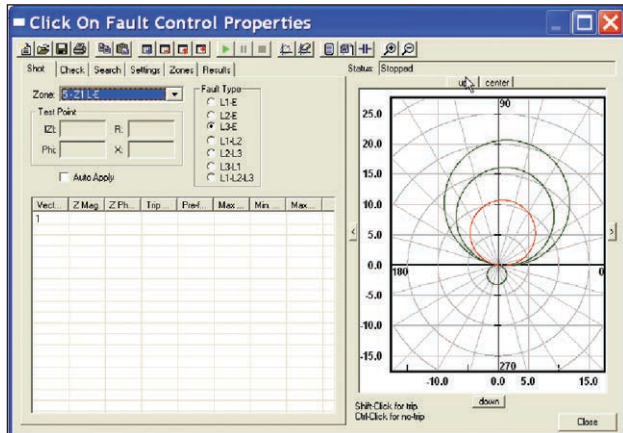

Click-On-Fault Test Screen with Multi-Zone Mho Distance Relay

On-Line Click-On-Fault Control

Online Click-On-Fault, launched from the AVTS Tools menu item, allows the user to quickly test impedance relay characteristics. The user can define the type of operating characteristic using the AVTS Theoretical Control, where the user can select a Mho circle, Ellipse, Tomato or virtually any operating characteristic. Characteristics can also be predefined and imported using either the Theoretical Object File Import or RIO File Import. To test the user simply selects the type of fault desired (Line to Earth, Line to Line etc) and clicks to set a test point, either as a Shot, or using the Search. Multiple test points

maybe selected and the software will automatically calculate the appropriate test currents and phase angles based upon the Settings and the Fault Type selected. In the Settings screen the user can define Constant Voltage, Constant Current or Constant Source Z (defined by Source Z, Source Angle and K). If using the Search the test will progress down a line, using click and drag, either as a ramp or a pulse ramp looking for the relay to operate. Test results are automatically displayed for each test point.

RIO File Import

In association with the Click-On-Fault test screen, Megger has also included a feature called RIO Import. RIO is a file format that defines the operating characteristic of specific relays. Customers who already have RIO files for their relays can import them into the Click-On-Fault RX diagram ready to test. Shown below is a RIO file import for a SEL 321 relay. Six shot test points are defined.

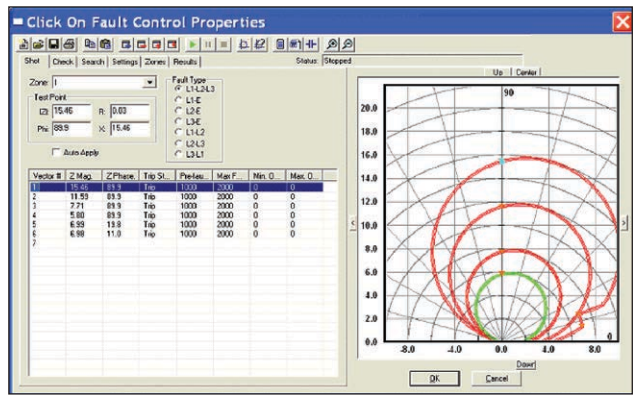

Click-On-Fault RIO Import of SEL 321 Characteristic

Test Wizards

All versions of AVTS software come with test wizards. The wizards walk the user through a step by step procedure to create a relay specific test(s). Wizards are available for the most common types of relays such as, Overcurrent, Over/Under Voltage, Frequency, Differential, Distance, Synchronizing and Directional. The following is a brief description of each test wizard.

Overcurrent Wizard - Provides automatic pickup, instantaneous pickup and timing. IEEE and IEC time curve algorithms are provided for automatic evaluation of the results. Digitized time curves for various electromechanical overcurrent relays are also available. For North American relays, a dc target and seal-in test is available. A test report will provide pass/fail information of the test results.

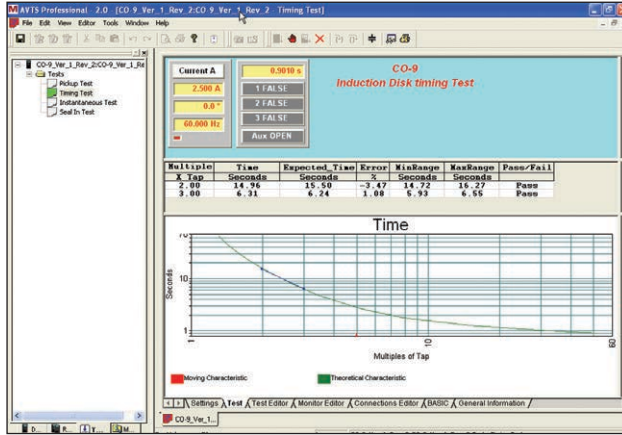

Over/Under Voltage Wizard - Provides automatic pickup and timing. A test report will provide pass/fail information of the test results based on user input.

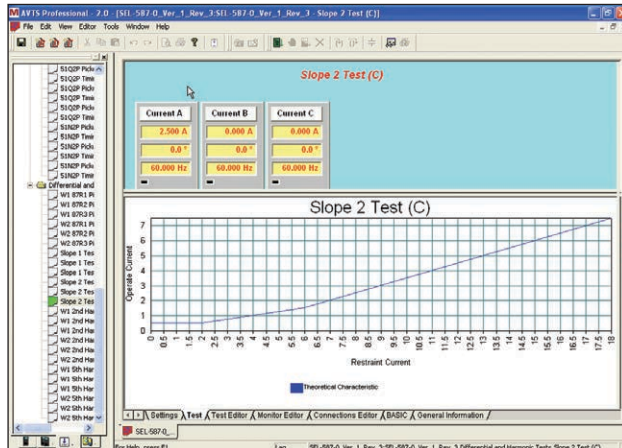

Resized Differential Slope Test Screen

Differential Wizard - Perform automatic winding pickup, differential characteristic (slope) test and harmonic restraint tests. In the figure below, the test result screen was resized using the mouse and the windows drag and drop feature. This allows the operator to more closely examine test points and results. The user may then generate a test report with the test results showing pass/fail based upon input by the user.

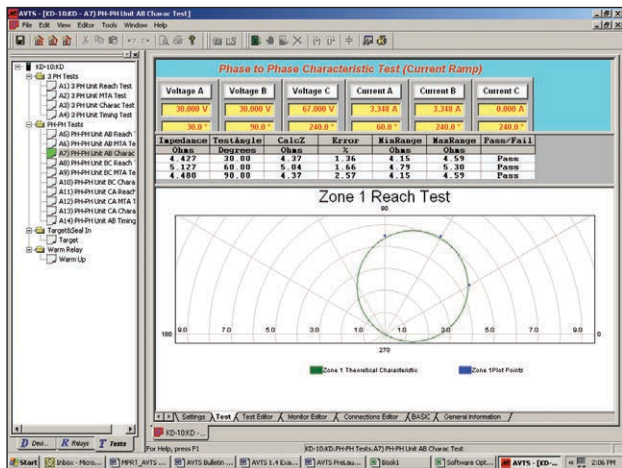

Typical Phase to Phase Characteristic Test

Distance Wizard - Perform automatic reach, max angle of torque and characteristic tests on single phase, three phase open delta or three phase Y connected relays. User may choose between fixed voltage and vary current or fix current and vary voltage. In addition, the user may select mho, lens, tomato or other basic distance characteristics using a pull-down menu. The test report will provide pass/fail information based upon user data input.

Directional Wizard - Perform automatic pickup test on directional elements. A report will provide test result.

AVTS Test Module Library

AVTS Basic includes a Relay Test Library database of almost 400 relay test modules, representing 17 different relay manufacturers. It includes electromechanical relays, solid-state relays, and microprocessor based relays, see Figure below. Test modules include test connection diagrams, all relay settings, and tests for virtually every element in the relay. Test modules automatically make pass/fail determination per the relay in-service settings and manufacturers' specifications. Many of the test modules include One-Touch test capability to automatically download the relay settings. In addition, the Library includes Special Applications test modules for End-to-End tests, testing transducers, and for testing using the symmetrical components calculator. The End-to-End tests include playback of DFR files, as well as multi-state playback using the Dynamic Control with the Recorder feature (Recorder feature records the test set output voltage and current waveforms, with the activity of the binary inputs and outputs).

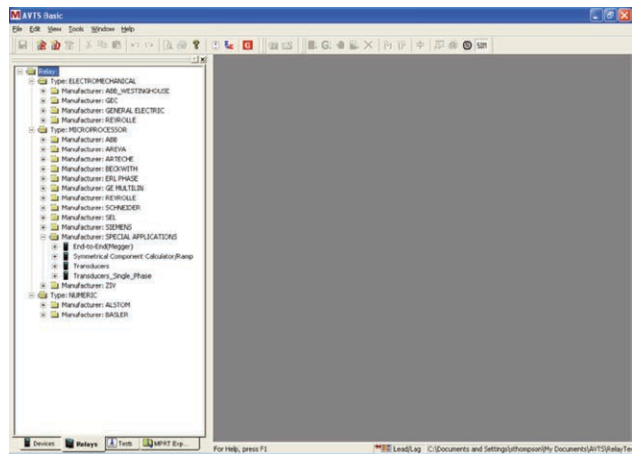

AVTS Relay Test Library Database

Import, Save, Execute Test Modules

AVTS Basic users can import test modules generated by Megger, or someone else using the Advanced or Professional versions of AVTS. The user can execute the tests, save results and print results. In addition, users can playback a Digital Fault Record, which has been generated by the Professional version of AVTS.

Time Saving

Each relay test module is an extremely valuable product for any relay test technician or engineer. It provides the user with a quick, easy way to test a specific relay to the relay manufacturer's specifications, as well as eliminates the time and costs associated with users having to create their own test routines.

One-Touch Test™

The One-Touch Test utilizes a Visual Basic® Script Control tool. The script file works with Megger Test Modules that have been specifically created to make use of this feature. The Script file allows AVTS software to communicate to a microprocessor-based relay via ASCII text serial communication, and download the relay settings into the AVTS relay Setting Screen automatically. Then, using the Group Execute feature in AVTS, automatically test the relay to the actual relay settings with one touch of the mouse button.

One-Touch Test Modules

One-Touch Test modules are currently available for a variety of relays. Test modules, which are One-Touch capable, save the user time, money and removes the possibility of human error when having to read over 100+ relay settings.

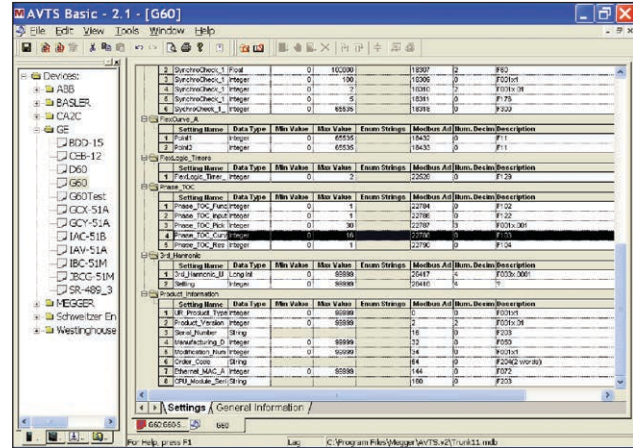

General Electric UR G60 Modbus Device Setting Screen

Electric UR Model G60 relay device settings screen can be seen in the above figure. Note the Modbus address for each setting in the relay is defined in the Device Setting screen. In this test module there are 295 settings that are automatically downloaded with 117 specific tests that can be selected as a sequence test.

Database

The database is Windows Access compatible. Data is saved in a conventional tree format to facilitate ease of use.

The following figure illustrates the AVTS navigator Relay tab when AVTS is in use. The relay data has been expanded to illustrate the organization.

The Organization is the method used to geographically locate the relays installed in this database.

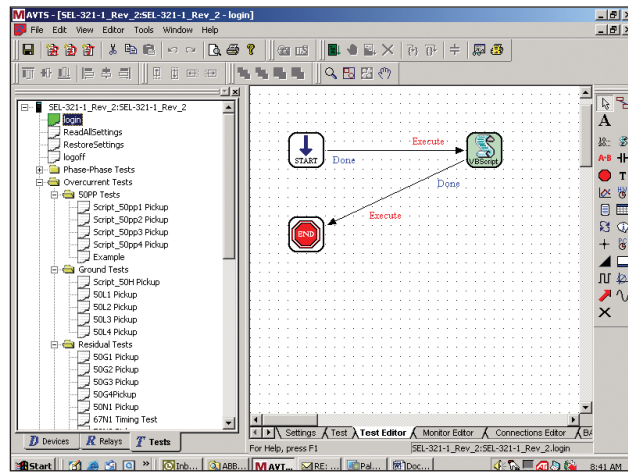

Log-in for SEL-321 Scripted Test Module

Modbus Communications

AVTS now has the capability to communicate with relays via the Modbus protocol. This allows the AVTS user the ability to automatically download relay settings from the relay via the Modbus addressing scheme into the AVTS relay setting screen. In addition AVTS can now monitor the relay protection or metering elements via the Modbus communications. This means the user will not need to change the relay outputs, thus test the relay without making any changes to the relay what so ever. Instead of the user having to read the meter values and manually input them into a result screen the software can now read the values automatically. This feature combined with the Sequence Test feature provides fully automatic testing without user intervention. As an example, the General

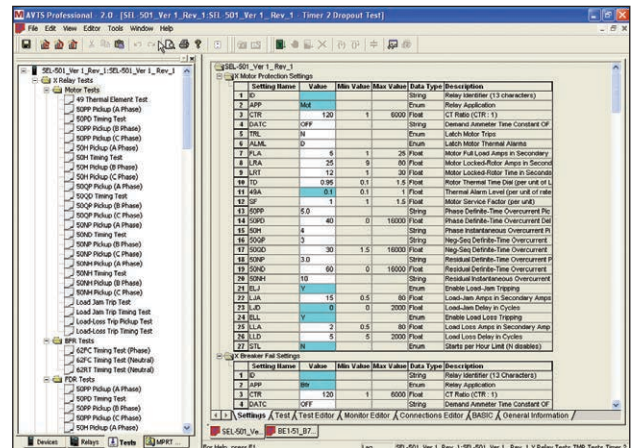

This example shows the organization tree descending by region, then substation, line, panel and finally the actual relay in the panel. The relays installed are then listed under that location. The hierarchal structure of AVTS includes up to 5 levels of organization.

Historical Test Results

In addition to showing the location of the relays in the system, the user can also look at the historical test records of any individual relay. This includes relay settings and recorded test results.

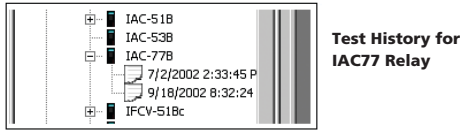

Test Reports

Individual test results can be viewed by double clicking on the desired result file. The test report can either be printed, or exported to Microsoft Word for user customized report generation using company logo, company standard format etc. This includes possible report requirements as specified by the National Electric Reliability Corporation (NERC) PRC-005-2 standard.

AVTS ADVANCED VERSION

The Advanced version includes all of the features previously described for the Basic version. In addition, it includes the very powerful Test Editor, Connection Editor, Dynamic Control, Analog Recorder, Basic Programming Tool, Modbus communications, SS1 File Connector, End-to-End test macros, and generic pre-constructed relay test modules. Advanced users can also playback a DFR file created by someone using the Professional version of AVTS. The following describes the additional features of the Advanced version of AVTS.

either. Simply click on the appropriate icon and drop into the test editor window. What may have taken weeks to “write” using basic programming now takes only minutes!

In addition, the test wizards automatically assemble and connect the appropriate icons for you. All you need to do is edit the appropriate control function to meet your specific needs. For example, using a right-mouse click on the Ramp Control Icon (in the Test Editor work screen), and then clicking on the Increment button, the user is able to adjust the increment value of each current increment for a pickup test.

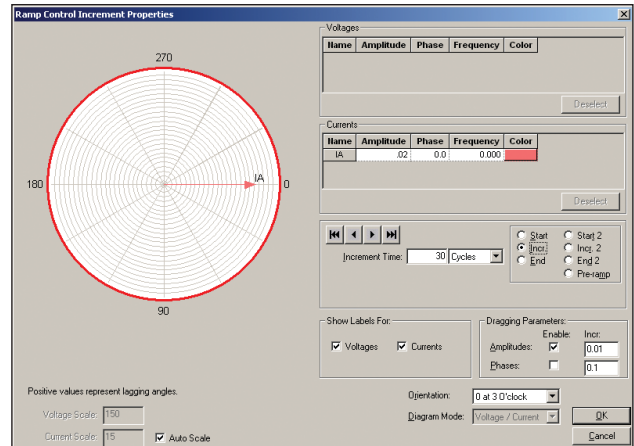

Adjusting Ramp Control - Single Phase Current Increment

Connections Editor

A picture is worth a thousand words. It seems like modern relays need a thousand connections today, so the Connections Editor is ideal to show how to connect the test system to the device under test. Powerful graphic tools are available to show test connections (see following Figure).

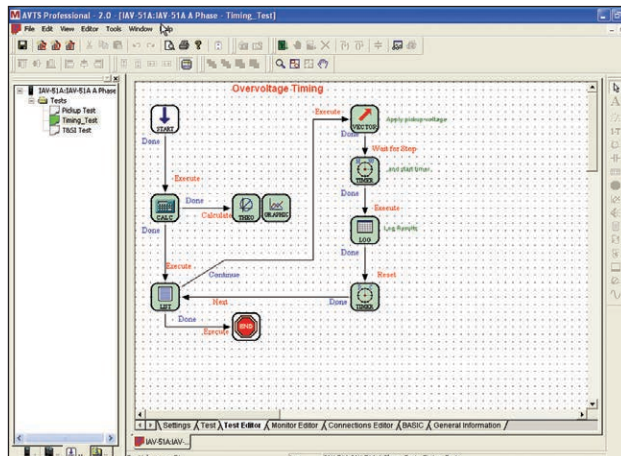

Test Editor Window

Test Editor

The real power of AVTS is in the Test Editor window. No more complicated test macros to write or edit. Instead, the user selects from a variety of icons representing various test macro functions. For example, in the Test Editor Window Figure, certain icons are selected and connected using the mouse. The software takes care of the rest. No more theoretical characteristic macros to write

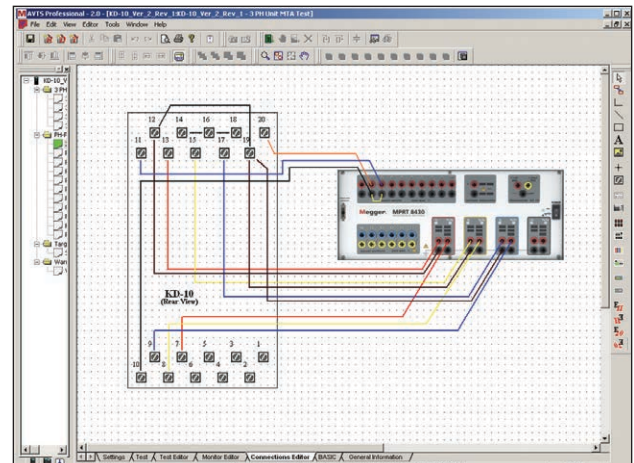

Connections Editor Screen provides relay test connections details

The Connections Images toolbar contains ten available icons for the user to define each as an image bitmap to import into the connection editor screen. This can include schematic internal diagrams of the relays, or other helpful information. Pictures of other test sets may also be used for illustration.

Dynamic Control

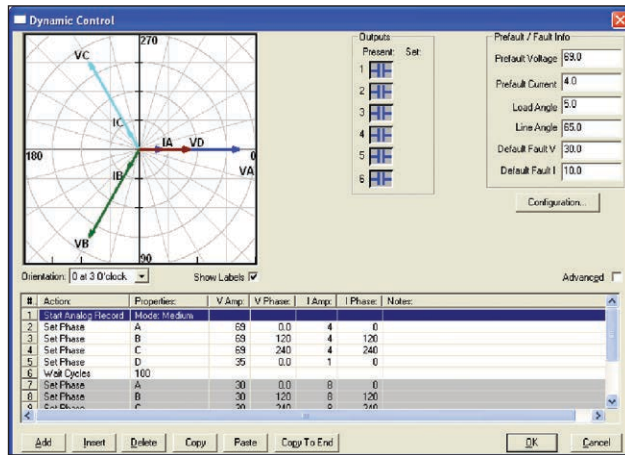

Dynamic Control Screen

The Dynamic Control, accessed from the Test Editor Screen, provides the user an easy means of settings up multi-state dynamic tests that are normally associated with trip and reclosing schemes or performing dynamic end-to-end tests. The figure above shows an example test setup using the Dynamic Control.

A “state” can be voltage(s), current(s), phase angle(s), timers, start and stop the analog recorder, set Boolean logic for the binary inputs, set binary output(s), or even use variables to set values. The test transitions from one state to another after a programmed time delay of either milliseconds or cycles, or after a trigger condition. In addition, the Dynamic Control allows the user to easily build harmonic waveforms with frequencies up to 1000 Hz. In conjunction with the Dynamic Control the Capture feature may be used to measure and display the output analog waveforms, binary inputs and outputs to evaluate the dynamic test results in a graphic form.

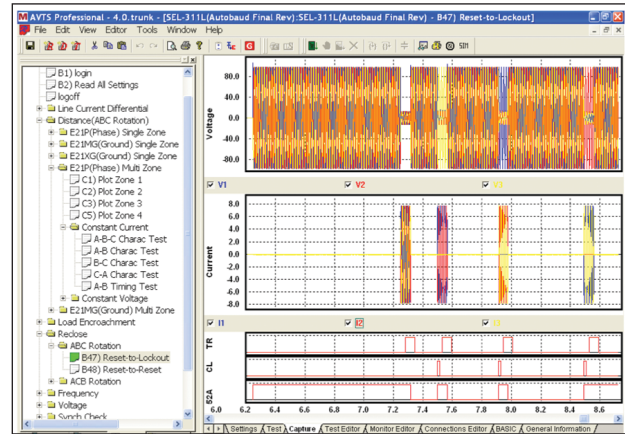

Display of “Recorder” Capture Feature in AVTS Software – SMRT/MPRT Records Voltage and Current Outputs, and Time-Synchronous Displays with Binary Inputs and Outputs.

Dynamic Analog Recorder

In association with the Dynamic Control is an analog recorder, which not only records the action of the binary inputs and outputs, but it also records the actual analog waveforms of the outputs, including DFR COMTRADE playback waveforms. For example, after running a reclosing sequence press OK to view the waveform capture screen. When the Waveform Capture screen comes up, press the Lightning Bolt button. This will load the data from the SMRT/MPRT test sets resulting in something like the waveforms shown.

The user can view the actual outputs waveforms as well as any selected binary inputs and or binary output contacts. It should also be noted that the user can record the complex waveforms that they applied using the harmonic waveform generator in the dynamic control.

Basic Programming Tool

The Basic Programming Tool provides a means to either import older test macros into AVTS and execute legacy test files, or to send the test system syntax commands to do special test applications not covered by the standard test modules, generic test modules, wizards, DFR playback, vector control, ramp control or dynamic control. These commands can be issued from the Basic Tool icon as part of a special test file.

SS1 File Converter

SS1 files are generated using Power System Simulation software programs by Electrocon® CAPE™ or Aspen One-liner®. By modeling the power system and using the SS1 files, the relay can then be tested dynamically using realistic system test scenarios. The SS1 File Converter will read the SS1 file and create a dynamic state sequence playback file. This file can be used in two ways. The first method of use is as a standard dynamic test. One application is the testing of impedance relays. By modeling the power system using simulation software, the relay can then be tested dynamically using realistic system test scenarios using actual line load conditions. The dynamic test can be used stand alone or as part of a more complex test module. The other application is as an End-to-End playback file, similar to a DFR playback file.

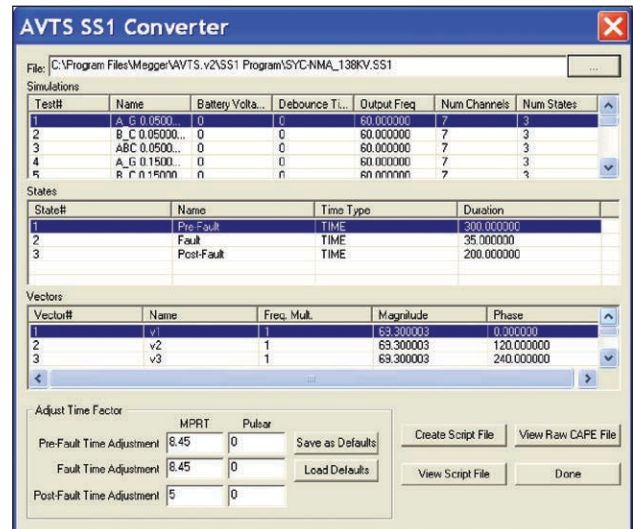

SS1 File Converter

End-to-End Test Capability

End-to-End testing usually involves GPS coordinated playback of a digital fault recorder (DFR) record, or a user- defined single or multi-state dynamic data playback by the test equipment. There are two methods to perform End-to-End tests with the SMRT/MPRT and AVTS software. One method requires **AVTS Advanced** using the **Dynamic Control** feature or use the SSI Dynamic Test and Test Editor. Using the Dynamic Control, the user can define pre-fault and fault states for single or multi-state playback, and initiate the test using the pull-down "Action" Command "Wait External" (triggers the test from a GPS programmable external trigger pulse). Another method for an End-to-End DFR Playback test is performed by using the DFR Waveform Viewer found in **AVTS Professional**. The DFR Viewer will allow the user to select the test file (a DFR playback test file) which is then loaded into the SMRT/MPRT test system. The test system then waits for a GPS trigger pulse to begin playing back the recording. Note that once a test file is created and saved, using either the Advanced Dynamic Control or Professional, that test file maybe transferred and executed by any other PC running AVTS 3.0 (or higher) **Basic, Advanced or Professional** versions, with any SMRT/MPRT unit. This provides user maximum flexibility of using any PC running AVTS, with any SMRT/MPRT unit, for end-to-end testing. A typical test equipment set up for End to End tests is shown in the following figure. It should be noted that even though the Megger Model MGTR (GPS Satellite Timing Reference) is shown, for maximum flexibility any GPS unit with a programmable output pulse maybe used for conducting end-to-end tests with the SMRT/MPRT and AVTS software.

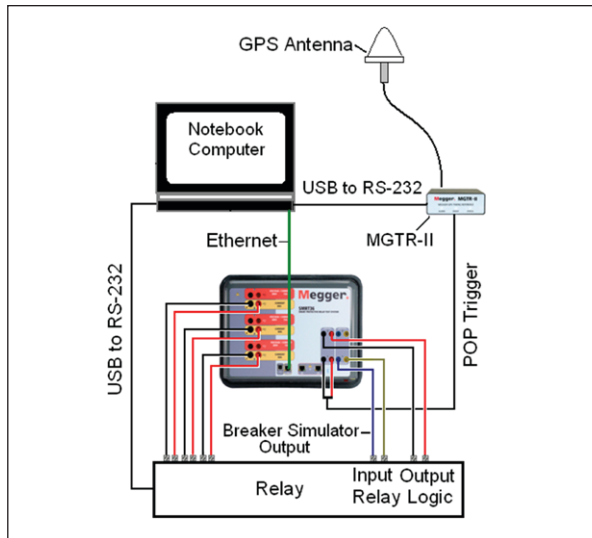

Typical End-to-End Test with MPRT

Import Aspen Relay Database®

In addition, relay settings may also be imported from other databases. For example, relay settings from the Aspen Relay Database® can be seen in the figure below.

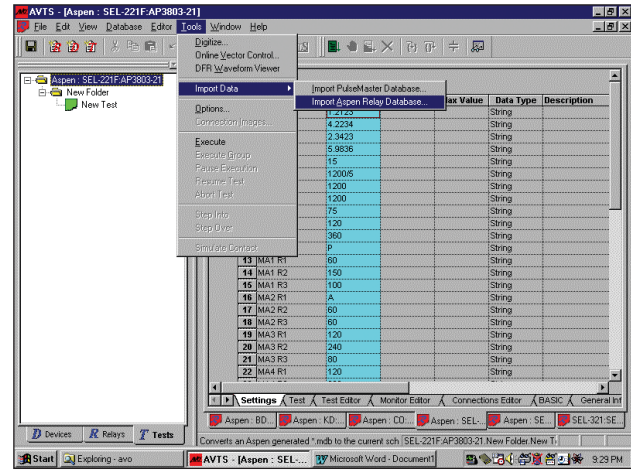

Import Relay Settings From Aspen Database

Waveform Digitizer

The AVTS Waveform Digitizer Tool enables the user to digitize waveforms and export them to a COMTRADE*.cfg and *.dat files for playback through the Test System. Waveforms from old strip chart recorders, hand drawn waveforms, and waveforms created by oscillographic functions of the modern microprocessor and numerical relays; any waveform that can be represented in a *.bmp format can be digitized. In addition, electromechanical relay analog time curves, that do not fit numerical algorithms, can be scanned into AVTS. The digitizer can be used to create a virtual time curve to be used in the timing test. For example, AVTS software comes with numerous analog curves already digitized and ready for use.

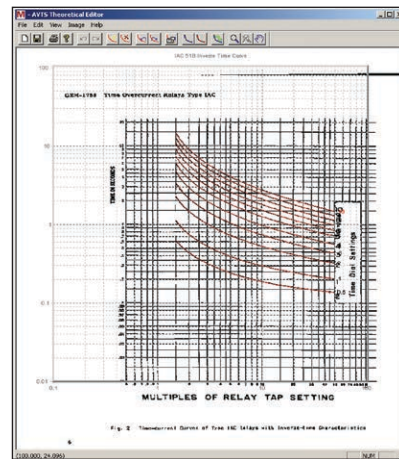

Westinghouse CO-9 Digitized Time-Current Curves

AVTS PROFESSIONAL VERSION

The Professional version includes all of the features previously described for the Basic and Advanced versions. It also includes special testing and editing tools for playback of Digital Fault Records or EMTP/ATP simulations that are in the IEEE C37.111 COMTRADE format. In addition, it includes the Waveform Digitizer, and the Visual Basic scripts for generating One Touch Test.

DFR Waveform Viewer and Playback

In addition to performing the steady-state testing, it is increasingly becoming a popular practice to perform dynamic and transient testing on protective relays. AVTS DFR Waveform Viewer has the capability of playing back transient waveform data to the Test System waveform generators. In other words, it can recreate a fault (waveforms...) recorded by a Digital Fault Recorder or simulated fault using EMTP/ATP programs. When DFR Waveform Viewer is invoked from the Tools menu, the screen called DfrWaveView dialog box will appear.

From this dialog box a user can convert digital fault recorder data, in COMTRADE format, to binary files compatible with the Test System waveform generators, select the channels and ranges to be uploaded, and upload and output the waveforms.

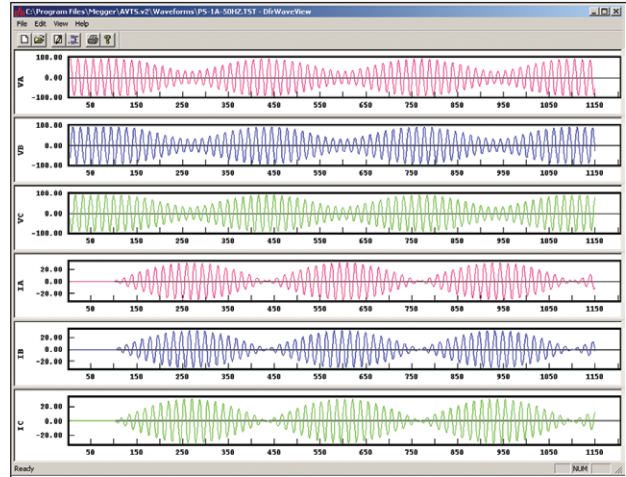

AVTS Professional Waveform Viewer Screen

Digital Fault Recorder Testing

Test File: C:\Program Files\AVTS\Waveforms\EMTPTest.TST Save Test OK

Config File: C:\Program Files\AVTS\Waveforms\AMRCAL.CFG Open Header Cancel

Frequency: 2592 Hz Rate: 1 PULSAR Commands: On Load Off Reset Allow Iterative Testing Number of Iterations: 1

Out Samples: 0 Pre Samples: 0

HEX File	Channel Name	Number	Unit	Location	Prefault	Fault	ax + b	Color	
VA	EP01 HEX	AP1-AMRAD 345	1	KV	1	71.33648	81.06854	229.25080	Red
VB	EP02 HEX	AP2-AMRAD 345	2	KV	1	72.85840	74.59122	210.94754	Green
VC	EP03 HEX	AP3-AMRAD 345	3	KV	1	72.14719	72.85969	206.36172	Blue
VD									
VE									
VF									
IA	EP04 HEX	ACA-AMRAD SID	4	KA	1	0.15011	2.16209	0.81153	Orange
IB	EP05 HEX	ACB-AMRAD SIDE	5	KA	1	0.12009	3.36325	0.95127	Yellow
IC	EP06 HEX	ACC-AMRAD SIDE	6	KA	1	0.15015	1.26122	0.35673	Black
ID									
IE									
IF									

DFR Test Editing Dialog Screen

In addition, special editing capabilities allow the user to replicate the pre-fault data for as many cycles as desired to insure that the device under test is properly polarized prior to applying the fault. Timing may be started in conjunction with the fault application, thus timing the replay event. Due to the wide operating bandwidth of the test system, there is no degrading of the recorded samples thus high fidelity of the playback waveforms is insured.

New End-to-End test capability has been added to the DFR Viewer User Interface screen, and allows GPS triggering of DFR files to be played back directly from the interface.

IEC 61850 Megger GOOSE Configurator

Megger GOOSE Configurator (MGC) provides easy to use tools for testing relays and substations using the IEC 61850 protocol. It is an optional software tool available with Basic, Advanced or Professional versions of AVTS Software. The configurator provides relay test engineers and technicians the capability to import parameters from configuration files in the Substation Configuration Language (SCL) format, and/or capture GOOSE messages directly from the substation bus. All imported GOOSE messages will be unconfirmed messages. Only captured messages are confirmed messages due to the sniffing feature of the MGC. Use the MGC Merge feature to compare imported SCL and captured GOOSE messages to verify all GOOSE messages needed to perform tests. Use them to configure the SMRT/MPRT to subscribe to preselected GOOSE messages by assigning the data attributes to the appropriate binary inputs of the SMRT/MPRT. Use the configurator to assign the appropriate binary outputs of the SMRT/MPRT to publish GOOSE messages simulating circuit breaker status.

MPRT IEC-61850 GOOSE Configurator

File Edit View Tools Help

SCL C DL MERGE Copy to MyGOOSE

My GOOSE	Capture	GOOSE Subscription	GOOSE Publication
	IEC GOOSE[MainID]Inst/LLN0\$GO\$pcb01[01-0C-CD-01-01...	BIN 1.2	
	IEC GOOSE[BackupCFG]LLN0\$GO\$GOOSE0\$set14[01-0C...		BOUT 1

MGC 'My GOOSE' with Assigned Binary Inputs and Outputs

After the appropriate assignments of binary inputs and outputs have been made, the My GOOSE test file can be saved for reuse. This provides both manual and automatic testing of the relay using either the Touch View Interface or AVTS software. Use basic on-line test tools or standard test modules in AVTS to perform automatic tests. Use the Dynamic Control in AVTS to perform high speed trip and reclose tests, or use to perform interoperability high-speed shared I/O tests between multiple IED's.

The MGC provides mappings of Boolean and Bit Strings and/or simulation of STRuct, Integer/Unsigned, Float and UTC datasets. The SMRT/MPRT meets the IEC 61850-5 standard, Type 1A, Class P 2/3, for high speed trip and reclose simulations.

ORDERING INFORMATION

Item (Qty)	Cat. No.
AVTS Basic Software	544244
AVTS Basic with IEC 61850 Megger GOOSE Configurator	1002-110
AVTS Advanced Software	5442455
AVTS Advanced with IEC 61850 Megger GOOSE Configurator	1001-037
AVTS Professional Software	5442465
AVTS Professional with IEC 61850 Megger GOOSE Configurator	1002-038
Extended Software Support Program	
1 to 2 users	10098
3 to 5 additional users	10097

UK
Archcliffe Road, Dover
CT17 9EN England
T (0) 1 304 502101
F (0) 1 304 207342

UNITED STATES
4271 Bronze Way
Dallas, TX 75237-1019 USA
T 1 800 723 2861
T 1 214 333 3201
F 1 214 331 7399

OTHER TECHNICAL SALES OFFICES
Norristown USA, Toronto
CANADA, Mumbai INDIA, Trappes
FRANCE,
Sydney AUSTRALIA,
Madrid SPAIN and
The Kingdom of BAHRAIN.

ISO STATEMENT
Registered to ISO 9001:1994 Reg no. Q 09250
Registered to ISO 14001 Reg no. EMS 61597
AVTS_DS_EN_V12
www.megger.com
Megger is a registered trademark