

# Megger<sup>®</sup>



## **SPI4000**

# Smart Primary Injection Test System

*User Guide*

## **IMPORTANT**

This user guide, as well as the hardware and software described in it, is furnished under license and may be used or copied only in accordance with the terms of such license. The content of this user guide is furnished for informational use only, and is subject to change without notice. Megger assumes no responsibility or liability for any errors or inaccuracies that may appear in this user guide.

The information and data in this user guide are proprietary. The equipment described herein may be protected by U.S. patents. Megger specifically reserves all rights to such proprietary information as well as rights under any patent, none of which is waived by the submission of this user guide.

Except as permitted by such license, no part of this publication may be reproduced, stored in a retrieval system, or transmitted, in any form or by any means, electronic, mechanical, recording, or otherwise, without the prior written permission of Megger.

Megger, the Megger logo are trademarks of Megger. All other trademarks are the property of their respective owners.

Notice to U.S. government end users. The hardware, software and documentation are "commercial items", as that term is defined at 48 C.F.R. §2.101, consisting of "commercial computer software" and "commercial computer software documentation," as such terms are used in 48 C.F.R. §12.212 or 48 C.F.R. §227.7202, as applicable. Consistent with 48 C.F.R. §12.212 or 48 C.F.R. §§227.7202-1 through 227.7202-4, as applicable, the commercial computer software and commercial computer software documentation are being licensed to U.S. government end users (1) only as commercial items and (2) with only those rights as are granted to all other end users pursuant to the terms and conditions set forth in the Megger standard commercial agreement for this software and hardware. Unpublished rights reserved under the copyright laws of the United States. The recipient, if a government agency, acknowledges that this user guide and the equipment described were procured with "Limited Rights" to technical data as described in ASPR 9-203 (b).

The Smart Touch View Interface includes an RTOS-resident computer program. This program belongs to Megger and contains trade secret ideas and information of Megger, written and designed at Megger, 4545 W. Davis, Dallas, Texas 75211-3422 USA

© 2023

**This document is the copyright of:**

Megger Limited, 4545 W Davis Street  
Dallas, Texas 75211-3422 USA  
PHONE: (800) 723-2861  
FAX: (214) 331-7399  
www.megger.com

WEEE



Waste Electrical and Electronic Equipment - The crossed out wheeled waste bin placed on Megger products is a reminder not to dispose of the product at the end of its life with general waste. Please utilize your Local WEEE collection facilities or observe all applicable Local requirements.

Megger is registered in the UK as a Producer of Electrical and Electronic Equipment. The Registration No is WEE/ DJ2235XR.s

Printed in the USA.

Megger reserves the right to alter the specification of its products from time to time without notice. Although every effort is made to ensure the accuracy of the information contained within this document it is not warranted or represented by Megger Limited to be a complete and up-to-date description.

For Patent information about this instrument refer to the following web site: [megger.com/patent](http://megger.com/patent)

### **Revision History**

<u>Revision</u>	<u>ECN #</u>	<u>Date</u>
1	Initial Release	8/18/2023

### **Declaration of Conformity**

Hereby, Megger Instruments Limited declares that the SPI4000, manufactured by Megger Instruments Limited described in this user guide, is in compliance with Directive 2014/53/EU. The full text of Megger Instruments EU declarations of conformity is available at the following internet address:

[Megger.com/Company/About-Us/Legal/EU declarations of conformity](http://Megger.com/Company/About-Us/Legal/EU%20declarations%20of%20conformity)

## Table of Contents

Section	Page
<b>Revision History</b> .....	3
1.0 <b>Introduction</b> .....	7
1.1 <b>Product description</b> .....	7
1.2 <b>Terminology</b> .....	7
1.2.1 Glossary of Terms for Circuit Breaker Testing .....	7
1.2.2.1 Pickup (Tap / Sensitivity Rating).....	7
1.2.2.2 Time Delay .....	8
1.2.2.2.1 Long-Time Delay .....	8
1.2.2.2.2 Short- Time Delay.....	8
1.2.2.3 Instantaneous .....	8
1.2.2.4 Test Multiple .....	8
1.2.2.5 Frame Size .....	8
1.2.2.6 Continuous Current Rating .....	8
1.2.2.7 Expected Trip Time .....	8
1.2.2.8 Interrupting Rating .....	8
1.3 <b>Applications</b> .....	9
1.4 <b>Megger web site</b> .....	9
2.0 <b>Safety Warnings and Standards</b> .....	10
2.1 <b>Warnings, Cautions and Notes</b> .....	10
2.2 <b>Additional Safety Warnings</b> .....	11
3.0 <b>Instrument Overview</b> .....	12
3.1 <b>Smart Touch View Interface</b> .....	12
3.2 <b>Descriptions of Inputs and Outputs</b> .....	13
3.2.1 Input Voltage .....	14
3.2.2 Input Cables .....	14
3.2.3 Grounding .....	14
3.2.4 External Binary Inputs .....	15
3.2.5 Output .....	15
3.2.5.1 Selection of Output Connections.....	15
3.2.5.2 Duty Ratings and Overload Capacities.....	17
3.3 <b>Graphical User Interface</b> .....	18
3.3.1 Home button.....	19
3.3.2 The Configuration button.....	19
3.3.3 File Folder button .....	19
3.3.4 View Report options button .....	19
3.3.5 Nameplate Data button .....	20
3.3.6 Breaker Settings button.....	21
3.3.6.1 As Tested Settings button .....	21
3.3.6.1.1 Normal - Document only one group of settings button .....	21
3.3.6.1.2 Document As Found and As Left settings button .....	21
3.3.6.1.3 Document As Found / As Left and AsTested settings button .....	21
3.3.6.1.4 Document As Found and As Left/AsTested settings button .....	22
3.3.6.2 Plot vs Current button.....	22
3.3.6.3 Plotting Phase button .....	22
3.3.6.4 Graphical Display .....	22
3.3.6.5 Long Time settings .....	22
3.3.6.6 Short Time settings.....	22
3.3.6.7 Instantaneous setting .....	22
3.3.6.8 Ground Fault settings .....	22
3.3.6.9 Special Functions button .....	22
3.3.6.9.1 Edit Curve file button .....	23
3.3.6.9.2 Load Different Curve File button.....	23
3.3.6.9.3 Turn On Logging of Curve Points button.....	23

3.3.6.9.4	View Log File button .....	23
3.3.6.9.5	Clear Log File button .....	23
3.3.6.9.6	Easy Load TCC File button .....	23
3.3.6.9.7	Help on Curve Scripting button .....	24
3.3.6.9.8	Display Large Graph button.....	24
3.3.6.10	X-Axis Display Nomenclature .....	24
3.3.7	Insulation Contact Resistance button.....	24
3.3.8	<b>Manual Test</b> button .....	24
3.3.9	<b>Long Time Test</b> button.....	25
3.3.10	<b>Short Time Test</b> button .....	25
3.3.11	<b>Instantaneous Time Test</b> button .....	25
3.3.12	<b>Ground Fault Test</b> button .....	25
3.3.13	<b>Help</b> button .....	25
3.3.14	<b>Test</b> buttons .....	25
3.3.15	<b>Manual Test</b> button .....	25
3.3.16	<b>Circuit Breaker Library</b> button .....	25
3.4	<b>Configuration of SPI4000 software</b> .....	25
3.4.1	<b>Configuration</b> .....	26
3.4.1.1	General Configuration Options .....	26
3.4.1.1.1	General Options Group .....	26
3.4.1.1.1.1	TouchMode On/Off .....	26
3.4.1.1.1.2	Show Input Voltage.....	26
3.4.1.1.1.3	Phase Labels .....	27
3.4.1.1.1.4	Auto Save .....	27
3.4.1.1.1.5	Default Settings Options .....	27
3.4.1.1.1.6	Change DB .....	27
3.4.1.1.2	PowerDB Options Group .....	27
3.4.1.1.2.1	Auto Fill PowerDB.....	27
3.4.1.1.2.2	Set PowerDB Form GUID .....	27
3.4.1.1.2.3	Map PowerDB Tags.....	27
3.4.1.1.2.4	Use Custom PowerDB Tags .....	27
3.4.1.1.3	Display Options Group .....	27
3.4.1.1.3.1	Use As Found / As Left.....	27
3.4.1.1.3.2	Include Graph In Report.....	28
3.4.1.1.3.3	English, Español, Francés, Deutsch.....	28
3.4.1.1.4	Version .....	28
3.4.1.2	System Configuration options.....	28
3.4.1.2.1	System Group.....	28
3.4.1.2.1.1	Line Frequency .....	28
3.4.1.2.1.2	Internal Temperature .....	28
3.4.1.2.1.3	Running on 480 (or 240) VAC Input.....	28
3.4.1.2.1.4	Adjust Current During Timing.....	28
3.4.1.2.1.5	Series Mode.....	28
3.4.1.2.1.6	Calibrate Unit .....	29
3.4.1.2.2	Timer Group .....	29
3.4.1.2.2.1	Timer Unit .....	29
3.4.1.2.2.2	Stop On Options .....	29
3.4.1.2.2.3	Firing Angle.....	29
3.4.1.2.3	Ethernet.....	29
4.0	<b>Operating Instructions</b> .....	30
4.1	<b>Safety Considerations</b> .....	30
4.2	<b>Set up of SPI4000</b> .....	30
4.2.1	Unpack System .....	30
4.2.2	Initial startup.....	30
4.3	<b>Main Startup Screen</b> .....	30
4.3.1	<b>Manual Test</b> .....	31
4.3.2	<b>Manual Modes of Operation</b> .....	31

4.3.2.1	Momentary (0% to 100% output power)	32
4.3.2.2	Continuous (0% to 100% output power)	33
4.3.2.3	Momentary (requested current)	34
4.3.2.4	Continuous (requested current)	35
4.3.3	<b>Advanced Automated Test</b>	36
4.3.3.1	Selecting a Curve	36
4.3.3.2	Selecting Generic Breaker	36
4.3.3.3	Selecting a Curve from Database	39
4.3.3.4	Selecting Tests	41
4.3.3.4.1	Long Time Tests	41
4.3.3.4.2	Short Time Tests	43
4.3.3.4.3	Instantaneous Tests	45
4.3.3.4.4	Ground Fault Tests	47
5.0	<b>Manual Testing of Motor Overload Relays and Circuit Breakers</b>	50
5.1	<b>Manual Test of Motor Overload Relays</b>	50
5.1.1	Testing Time Delay	51
5.2	<b>Manual Testing of Molded Case and Low Voltage Power Circuit Breakers</b>	53
5.2.1	Testing Time Delay	54
5.2.2	Testing Instantaneous Trip	56
6.0	<b>Maintenance</b>	58
6.1	<b>General Maintenance</b>	58
6.2	<b>Cleaning</b>	58
6.3	<b>Updating SPI4000 Software and Firmware</b>	58
7.0	<b>Specifications</b>	60
8.0	<b>Accessories</b>	61
8.1	<b>Included accessories</b>	61
8.2	<b>Optional accessories</b>	62
9.0	<b>Calibration, Repair and Warranty</b>	63
9.1	<b>Warranty</b>	63
9.2	<b>Return procedure</b>	63
9.3	<b>Lifting and Transporting</b>	64
9.3.1	Lifting	64
9.3.2	Transporting	65
10.0	<b>Decommissioning</b>	65
10.1	<b>WEEE Directive</b>	65

## 1.0 Introduction

This user guide contains information regarding the correct use and safe handling of the SPI4000. This user guide is on-board the Smart Touch View Interface, and can be quickly referred to by pressing the “?” Help button located on the main screen. Please read the section ‘**Safety, Warnings and Standards**’. This section contains information regarding your personal safety when using the SPI4000.

### 1.1 Product description

The Model SPI4000 is a high current primary injection test system with the flexibility to test a wide variety of devices such as low-voltage power circuit breakers, molded-case circuit breakers equipped with thermal magnetic or electronic trip devices, switchgear CT’s, overcurrent relays, and thermal relays via primary injection. The SPI4000 is designed to test a wide range of circuit breakers, with ratings up to 4000 Amps frame size. The unit is fully compliant with NEMA AB-4 test guidelines.

The SPI system is the FIRST high current test system that allows a user to type in a predetermined current amplitude and the SPI system will generate and regulate the requested high current without preheating the test sample by pulsing the output current at high amplitudes. The SPI system also has the unique ability to turn on at the current zero crossing every time for any load by automatically adjusting the output firing angle. This eliminates DC offset for every circuit breaker type and the need for the user to determine and manually adjust the firing angle for different loads and circuit breakers.

The SPI system can be operated in a fully automated or manual mode via a full color, high resolution, TFT LCD touch screen controller (STVI). The optional controller provides the overall system operations and data storage functions. The unit comes with a USB memory stick which includes the PowerDB SPI4000 software to load onto a PC.

The touch-screen controller allows the use of Megger’s PowerDB software, which gives the user the ability to download a TCC (Time Current Curve) into the SPI test system. By using a downloaded curve, the user will be provided with Pass/Fail results directly on the SPI test report. This provides the user with an immediate answer to whether the test sample is working correctly or requires maintenance.

### 1.2 Terminology

The acronyms, terms, and definitions used throughout this manual are described below:

#### 1.2.1 Glossary of Terms for Circuit Breaker Testing

The SPI4000 software screens prompt the user to select, or set, various values. The values vary depending on the protective device under test. Many of the terms used are similar in nature and mean virtually the same thing regardless of the type of breaker. For example, the term Time Dial is commonly used to define the time dial setting on the device under test. Unfortunately, some of the terms described here may apply to different types of devices under test in different ways, and thus may not cover every possible device made. However, it is hoped that this glossary will help the user to understand every setting value on every device under test.

##### 1.2.2.1 Pickup (Tap / Sensitivity Rating)

A numerical value associated with a tap or sensitivity rating setting on the device under test. It is used to define a setting value, pick up value, or minimum operating point, of the device under test.

### 1.2.2.2 **Time Delay**

It is a numerical value of time, normally associated with the minimum operating time of the device under test. Low Voltage Power Circuit Breakers are available with three types of tripping characteristics: Long-Time, Short-Time, and Instantaneous.

#### 1.2.2.2.1 **Long-Time Delay**

The long-time delay characteristic is normally associated with direct acting low voltage power circuit breakers providing overload protection with typical time delays of approximately 10 -60 seconds at 300% of pickup.

#### 1.2.2.2.2 **Short-Time Delay**

The short-time delay characteristic is normally associated with direct acting low voltage power circuit breakers providing protection for short circuit or fault conditions. It is used whenever a small delay is necessary for coordination or selectivity with other protective devices. Typical delays of this type characteristic are approximately 6-30 cycles.

### 1.2.2.3 **Instantaneous**

A numerical value associated with a tap setting of the instantaneous element of the device under test. It is used to define a pickup value, or minimum operating point, of the instantaneous element of the device under test. The instantaneous trip characteristic is used for short circuit or fault protection and has no intentional time delay.

### 1.2.2.4 **Test Multiple**

A numerical value normally associated with conducting timing tests. Multiples are normally expressed in terms of whole numbers like 2, 3, 4, etc., times the Device under test Pickup, or Tap, value of the device under test. Fractions of test multiples may also be entered, and the appropriate test values and theoretical trip times will automatically be calculated.

### 1.2.2.5 **Frame Size**

The frame rating is the maximum continuous current rating in amperes of all parts except the overcurrent device. All current-carrying parts, contacts, and pivot points are designed to carry the amperes up to the frame size rating without exceeding heating limits.

### 1.2.2.6 **Continuous Current Rating**

The continuous current rating is a current value equal to or less than the frame rating. This value of current is printed or stamped on the overcurrent device. It is possible to have a 600-ampere frame rating, with a continuous current rating of only 100 amperes (due to the size of the overcurrent trip device).

### 1.2.2.7 **Expected Trip Time**

A numerical value which expresses the operating time of the device under test.

### 1.2.2.8 **Interrupting Rating**

A numerical value associated with the highest current at rated voltage that the device can interrupt without external damage.



### 1.3 Applications

#### **SPI4000**

Universal in application, the SPI4000 is a high current primary injection test unit with the ability to perform high current commissioning tests as well as the testing of virtually all low-voltage molded-case and metal-clad direct-acting ac circuit breakers produced by General Electric, Westinghouse, Eaton, Federal Pacific Electric, Square D, Gould, ABB, ITE, Siemens, Merlin Gerin and other manufacturers. Rugged and reliable, this low voltage Circuit Breaker Test set is designed to provide years of trouble-free field operation. The test set also may be used for other high-current applications such as performing ratio tests on current transformers, heat runs or primary injection testing on high-voltage breakers and their associated protective relays.

#### **PowerDB Software**

PowerDB software is the premier software for automated testing, report generation and maintenance record keeping of all low voltage circuit breakers. PowerDB not only has the ability to control any SPI system, but also uses the test results to provide the operator with Pass/Fail evaluations. These results are then recorded in the PowerDB database for report generation and archive. PowerDB can also accept other test data such as contact resistance and insulation resistance measurements, so a complete circuit breaker report can be maintained in one database location.

### 1.4 Megger web site

Occasionally an information bulletin may be issued via the Megger web site. This may concern new accessories, new usage instructions or a software/firmware update. Please, occasionally check on the Megger web site for anything applicable to your SPI4000.

[www.megger.com](http://www.megger.com)

The rest of this page is intentionally left blank









## 2.0 **Safety Warnings and Standards**

This instrument has been designed for operator safety; however, no design can completely protect against incorrect use. This instrument must be operated, used and serviced ONLY by trained, qualified personnel. Misuse of electrical test equipment can result in personal injury and damage to the apparatus under test. **Obey all applicable safety rules and regulations at all times.** Electrical circuits are dangerous and **can be lethal** when lack of caution and poor safety practices are used. There are several standard safety precautions that should be taken by the operator.

### 2.1 **Warnings, Cautions and Notes**

Where applicable, internationally recognized defined IEC safety markings have been placed in the user guide, and on the instrument, to notify the operator to refer for instructions on correct use or safety related topics. Refer to the following descriptions and table of symbols.

Descriptions
<b>DANGER:</b> Indicates a dangerous situation, which could cause serious injury or death
<b>WARNING:</b> Indicates a potentially dangerous situation, which could cause serious injury or death
<b>CAUTION:</b> Indicates a situation which could lead to damage of the equipment or environment
<b>NOTE:</b> Indicates important instructions to perform the relevant process safely and efficiently
<b>APPLICATION NOTE:</b> Indicates a possible application of the instrument

Symbol	Description
	Direct Current
	Alternating Current
	Both direct and alternating current
	Earth (Safety Ground) Terminal. This terminal <b>must</b> be connected to an earth ground before making other connections to the instrument and prior to operating it.
	EU conformity. Equipment complies with current EU directives.
	The crossed out wheeled waste bin placed on Megger products is a reminder not to dispose of the product at the end of its life with general waste.
	Warning/Caution, risk of electric shock. Indicates that high voltage is present on the terminal. Use extreme caution.
	Warning/Caution, this symbol indicates that the operator of the instrument must refer to the user guide for further explanation and clarification.



**WARNING:** Under no circumstances should the operator or technician attempt to open or service any Megger instrument while connected to a power source. Lethal voltages are present and may cause serious injury or death!



### **Additional Safety Warnings**

The following are some additional safety related items associated with the SPI4000.

- The test system must only be used by suitably trained and competent persons.
- Read and understand all safety precautions and operation instructions before attempting to use this test system.
- The purpose of this equipment is limited to use as described in this user guide. Should a situation arise that is not covered in the general or specific safety precautions please contact Megger regional representative or Megger, Dallas Texas.
- Safety is the responsibility of the user. Misuse of this test system can be **extremely dangerous**.
- Always start with the power **OFF**, before connecting the power cables. Make sure to connect the earth ground terminal to a suitable earth ground **before** attempting to make test connections.
- **DO NOT** attempt to use the unit without a safety ground connected.
- Always use properly insulated test leads. **DO NOT** use cracked or broken test leads.
- Always turn the test system off before disconnecting the power cables.
- **DO NOT** use the SPI4000 in an explosive atmosphere.
- Observe all safety warnings marked on the equipment and in the user guide.
- For safety related or other important topics in this user guide, like the statement below, will be notated with the adjoined symbol. Read the topic carefully as it may relate either to the safe operation of the instrument or the safety of the operator.



**Under no circumstances should the operator put their hand or tools inside the test system chassis area with the instrument connected to a power source. Lethal voltages are present and may cause serious injury or death!**

### 3.0 Instrument Overview

This section of the user guide contains the information that you will need to set up and use the SPI4000 with the optional Smart Touch View Interface (STVI).

 **NOTE:** If using a PC loaded with the PowerDB software to control the SPI4000, the same connection port is used as the STVI.

### 3.1 Smart Touch View Interface

The optional STVI is a user-friendly interface to control the Megger SPI test equipment. This user guide contains the information that you will need in order to set up and use your STVI with the SPI Device. How the unit operates, some of the different types of testing you can do, and how to save and view your test results with the Smart Touch View Interface software is described. It also covers running the SPI4000 using the PowerDB software on your PC.

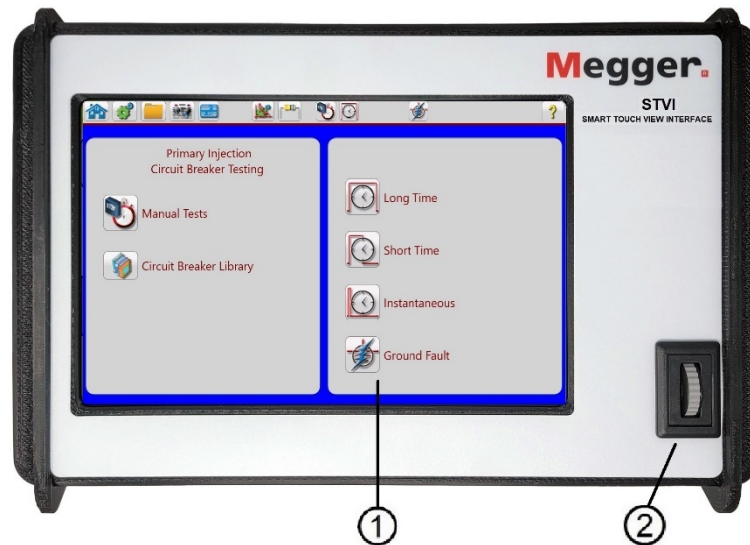

Figure 1 STVI-10 Front Panel

1. **LCD Color Display** ① – this 10.1-inch (25.65 cm) touch panel display provides high resolution, and features Wide Viewing Angle Technology with high luminance. The Display, is a user-friendly interface to control the SPI4000.
2. **Control Wheel** ② – the Control Wheel provides the ability to manually adjust values.

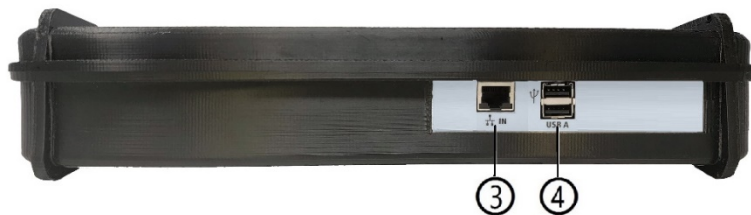



Figure 2 STVI Ethernet and USB Ports

3. **Ethernet Port** ③ is a 10/100BaseTX port. It is the primary PC connection port. This port supports MDI/MDI-X auto cross over configuration, which means both standard and “crossover” Ethernet cables may be used. This port provides the optimal method for downloading files, and updating the unit’s firmware as required. The STVI comes standard with a crossover cable.

 **NOTE:** The STVI gets Power Over Ethernet (PoE) of 48 Volts DC at 0.5 A from the SPI4000 Ethernet Port.

4. **USB Interface Terminals** ④ - there are two Type A USB terminals available. The USB 2.0 Interface requires a Type B “downstream” connector, and is primarily used as a communication and control port when used with Megger PowerDB software. A USB cable is not provided with the test set or in the accessories. For computer control, an Ethernet cable is provided with the STVI. However, should the user desire to use the USB port any standard USB Type A cable will work with the unit. This port may also be used to update the STVI software and/or the SPI4000 firmware.

### 3.2 Descriptions of Inputs and Outputs

The following are descriptions of the SPI4000 inputs and output connections.

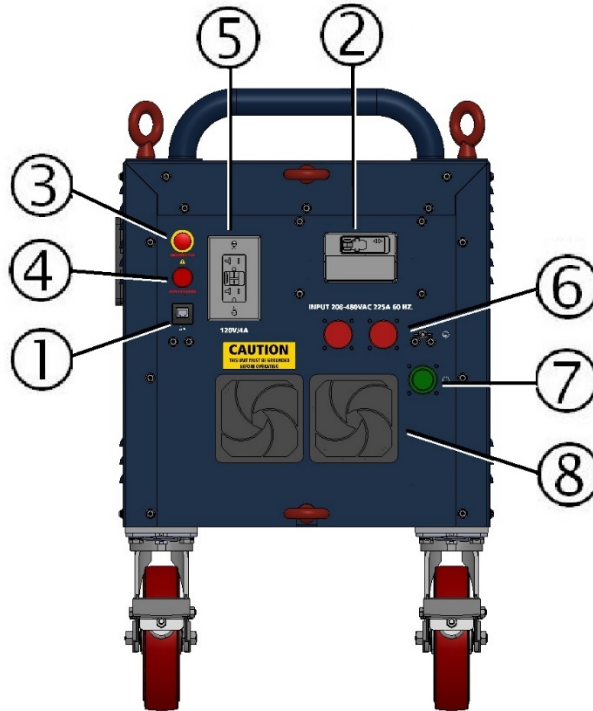



Figure 3 SPI4000 Power Input connections and controls

1. **Ethernet Port** ①: Connection for control of the instrument. Contains Power Over Ethernet (PoE) for STVI operation.
2. **Circuit Breaker** ②: Functions as the input Power ON/OFF switch, and also provides short-circuit and overload protection.
3. **Emergency Stop Button** ③: Provides emergency shutoff to the unit.
4. **Red Light Indicator** ④: Provides indication that the unit is outputting current.
5. **Auxiliary Outlet** ⑤: A ground fault protected 120-volt outlet is provided for convenient connection of accessory equipment.
6. **Power Input Receptacles** ⑥: Receptacles for power input connection.
7.  **Equipment Earth Ground Connection** ⑦: Test set chassis ground. For safety purposes, this should be connected to a power system ground.
8.  **Fans** ⑧: These fans provide cooling to the output transformer.

### 3.2.1 Input Voltage

The SPI4000 Circuit Breaker Test Set is designed to operate on a single-phase voltage source. See nameplate for input rating.

### 3.2.2 Input Cables

The power source must have sufficient capacity to maintain RATED input voltage at the INPUT terminals of the test set. All units are supplied with 15-foot (4.6 m) 2/0 AWG (9.27 mm) input cables with locking connectors on one end. This is done to provide a locking input connector, for safety purposes, along with input cables that are appropriate for a minimal amount of voltage drop from the input source to the input terminals of the test set. Although the test set is designed to operate satisfactorily at 95-105% of rated voltage, any drop in voltage below RATED at the input terminals will result in a proportional decrease in the maximum available output.



**NOTE:** To achieve published output currents, the rated input voltage must be maintained at the test set input terminals during the test.

### 3.2.3 Grounding

For safety, ground wires must be connected to the test set chassis to energize the test set. One ground lead must be connected to the ground terminal located just below the input plug to system ground. The size of the conductor should be not less than 6 AWG (16 mm<sup>2</sup>). Due to the special ground interlock circuit, a second lead must be connected from the green GND binding post to a separate, but compatible system ground. This will ensure that a ground has been achieved and allow the test set to be energized.



#### **WARNING**

***For safety of the operator, it is essential that the test set be properly and effectively grounded.***

The rest of this page is intentionally left blank

### 3.2.4 External Binary Inputs ②

The following are descriptions (from right to left) of the External Binary Input terminals located on the Output Section of the unit.

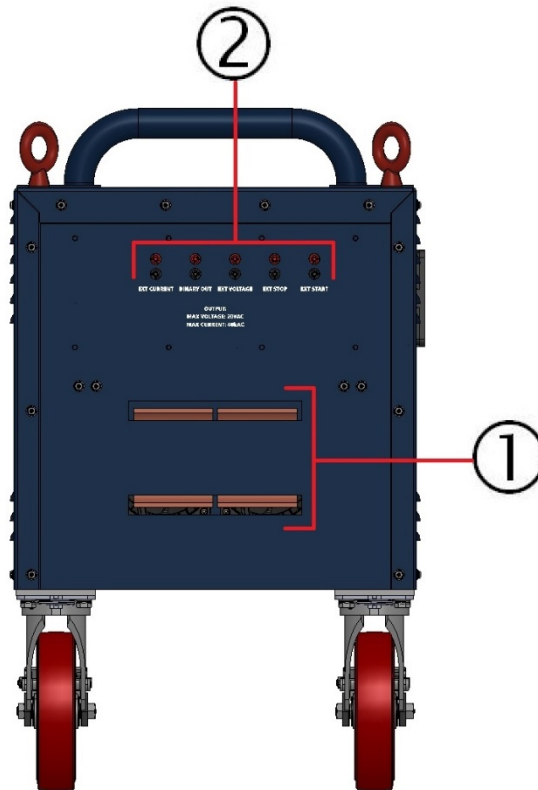

Figure 4 Output Connections and Binary Inputs

1. **EXT. START** Terminals - An external switch will be able to be plugged into these terminals to provide remote initiation of the test set (future feature, not released in current model)
2. **EXT. STOP** Terminal – An external contact can be plugged into these terminals to provide a remote stop.
3. **EXT. VOLTAGE** – External voltage (0-300V) can be measured on these inputs. This allows the unit to measure millivolt drop when testing breakers. (Future feature, not released in current model)
4. **BINARY OUT** – Future feature.
5. **EXT. CURRENT** – Future feature.

### 3.2.5 Output ①

The following describes the possible output connections, the duty ratings and overload capabilities of the unit.

#### 3.2.5.1 Selection of Output Connections

Two output connections, parallel and series, provide various voltage and current ratings to adapt the SPI4000 Circuit Breaker Test Set to a wide variety of test circuit impedances.

The test set can be operated most efficiently by utilizing the parallel connection, which provides the HIGHEST CURRENT rating consistent with being able to obtain the desired test current. In this way, finer adjustment can be obtained by making maximum use of the variable autotransformer range. Even the smallest currents can be obtained from the parallel connection. The series connection should be used only when testing high impedance devices, where the parallel connection does not produce enough voltage to “push” the desired test current through the device. The operator should

start with the parallel connection and move to series connection only when necessary. To operate the test set in parallel connection requires the operator to install the Parallel Adapter plates to the output stabs, see the following figure.

**Parallel Adapter plates  
installed onto the output stabs**

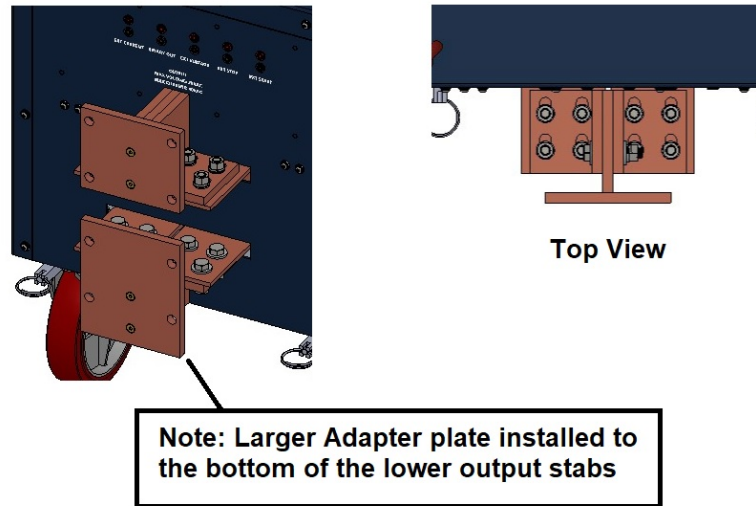
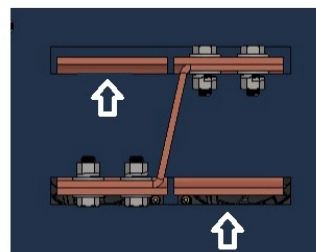

Figure 5 Installing Parallel Adapters

After installing the Parallel Adapter plates, the appropriate CBS-1, CBS-2, or CBS-3 circuit breaker stabs adapters can be mounted to the parallel adapter plates. Note that the CBS-FLEX Adapter mounts to the output stabs similar to the Parallel Adapter plates.

To operate the test set in series connection requires the operator to install the Series Adapter plate to the output stabs, see the following figure.

**Series Adapter plate installed  
onto the output stabs**



**Connect test cables to the  
stab plates as indicated by  
the arrows.**

Figure 6 Series Connections with Adapter plate

With the test set in series requires that test cables be connected to the output stab to complete the series connection, as shown in the figure above.



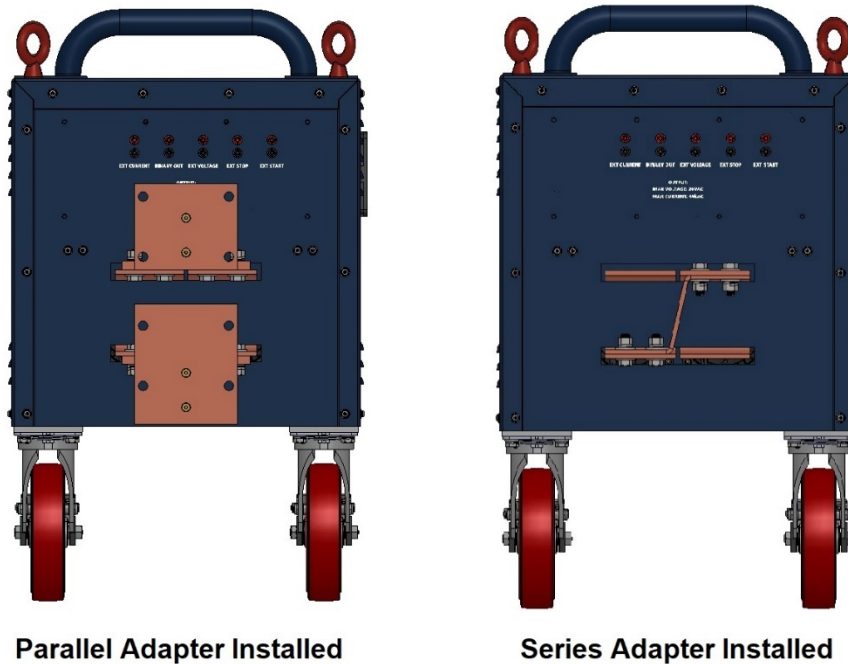

Figure 7 Parallel and Series Adapter plates installed

**⚠ APPLICATION NOTE:** When the output of the test set is in series configuration, cabling must be used to connect the output of the test set to the test specimen, and the setting under the **System** Tab must have **Series Mode** turned **ON**, see **sections 3.4.1.2 System Configuration Options**, and **3.4.1.2.1.5 Series Mode**.

**Parallel Output Connections:** The SPI4000 is equipped with Parallel Adaptors to use Meggers standard CBS-1, CBS-2, and CBS-3 breaker stab sets, when operating in the parallel mode. Additionally, adaptors allow for the use of CBS-FLEX, which are flexible stabs that allow connection to most breakers. The flexible stabs are longer and allow for easier connection to most breakers, but create extra impedance, which will affect the maximum output of the unit.

**Series Output Connections:** As previously noted, when operating in the series mode test leads must be connected to the two output stabs that are not connected to the Series Adapter bar. To obtain the highest level of current it is worthwhile to sacrifice cross section of the output test leads for the sake of reducing length. Every inch of lead that can be eliminated provides a worthwhile increase in available test current. Heating is not a significant problem in testing, even though the leads become hot. The use of 4/0 AWG (11.7 mm) welding or motion picture cable is convenient for constructing test leads. Paralleling of sufficient cables provides higher test currents. Each cable can be fitted with a compression lug on each end, then bolted to the output stabs of the test set and the breaker.

The two cables between the test set and the breaker should be twisted together or bundled with tape or cord to maintain the close proximity which minimizes inductive reactance.

It is sometimes necessary to use bus bar in order to obtain the desired maximum current. When using bus bar, the buses should be run parallel and kept as close to one another as possible, without touching each other.

### 3.2.5.2 Duty Ratings and Overload Capacities

The SPI4000 is rated on a continuous duty basis as described by NEMA for test equipment in intermittent service; that is, 30 minutes ON followed by 30 minutes OFF. This means that, the

equipment can supply rated output current for a maximum period of 30 minutes ON provided a 30-minute cooling OFF period follows. This is a satisfactory basis of rating for testing of circuit breakers and primary injection testing of relays. When the equipment is being used for heat runs on cables, bus bars, terminations, etc., the 30 minutes ON time may be exceeded. In such cases the output current should be limited to 4000 amps.

In addition to the continuous duty rating defined above, all units have considerable short-time overload capability. Duration of the overload is governed by ambient temperature and thermal considerations within the test set. The maximum current available is determined essentially by the impedance of the load. The duty cycles of the SPI4000 are as follows:

**DUTY CYCLES FOR SPI4000  
CIRCUIT BREAKER TEST SET  
(Current Rating through a Circuit Breaker)**

<b>Current</b>	<b>Time On</b>	<b>Time Off</b>
4,000A	Continuous	N/A
4,500A	30 Min	30 Min
6,000A	15 Min	45 Min
15,000A	2 Min	60 Min
40,000A	2.5 Sec	12 Min

**THERMAL SET POINTS\***

Warning: 80°C / 176°F

Shutdown: 95°C / 203°F

See the latest SPI4000 Data Sheet for complete list of specifications. Time On and Time Off is based upon an ambient temperature of 23° ± 5° C (73° ± 9° F). Higher ambient temperature may result in shorter On times, and longer Off times.

**3.3 Graphical User Interface**

The SPI4000 is controlled by a computer software interface and can be run from a laptop or the Smart Touch View Interface (STVI). See the following descriptions of the startup screen.

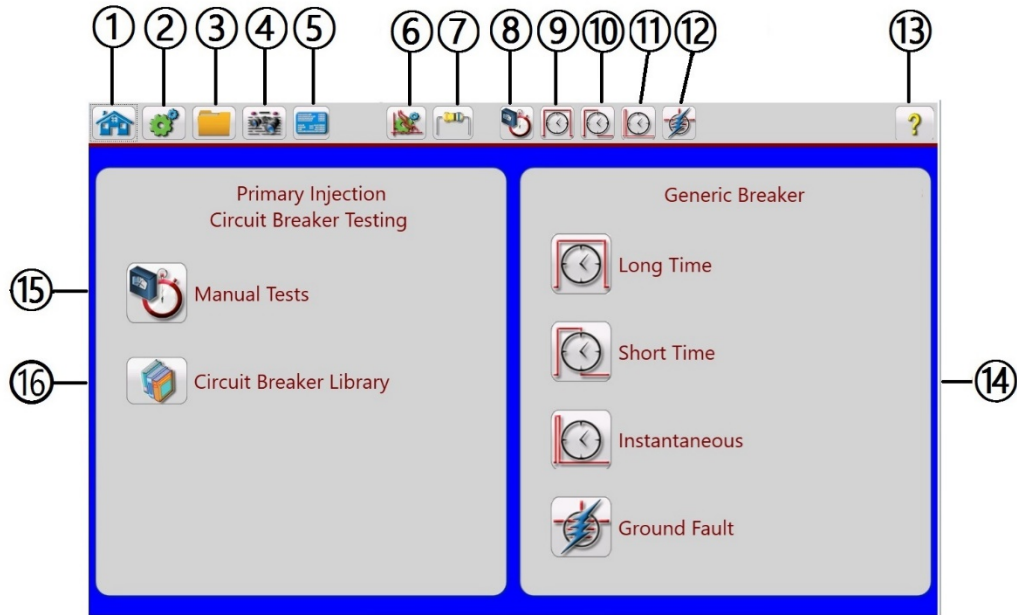

Figure 8 Main Startup Screen Identifications

3.3.1 ① Home button

Pressing the Home button from any screen will return the user to the Main Startup Screen

3.3.2 ② The Configuration button



Press this button to go to the SPI4000 software Configuration Screen. See Section 3.4.1 Configuration for more information of the Configuration Screen.

3.3.3 ③ File Folder button



To access the File Management system, touch the File Folder top tool bar. It provides the user the ability to save tests in different formats, or open saved tests or new files.

3.3.4 ④ View Report options button



To view a test result, press the View Report button. The report may be saved and exported to the PowerDB database for record keeping. Pressing on the View Report button will provide the following figure.

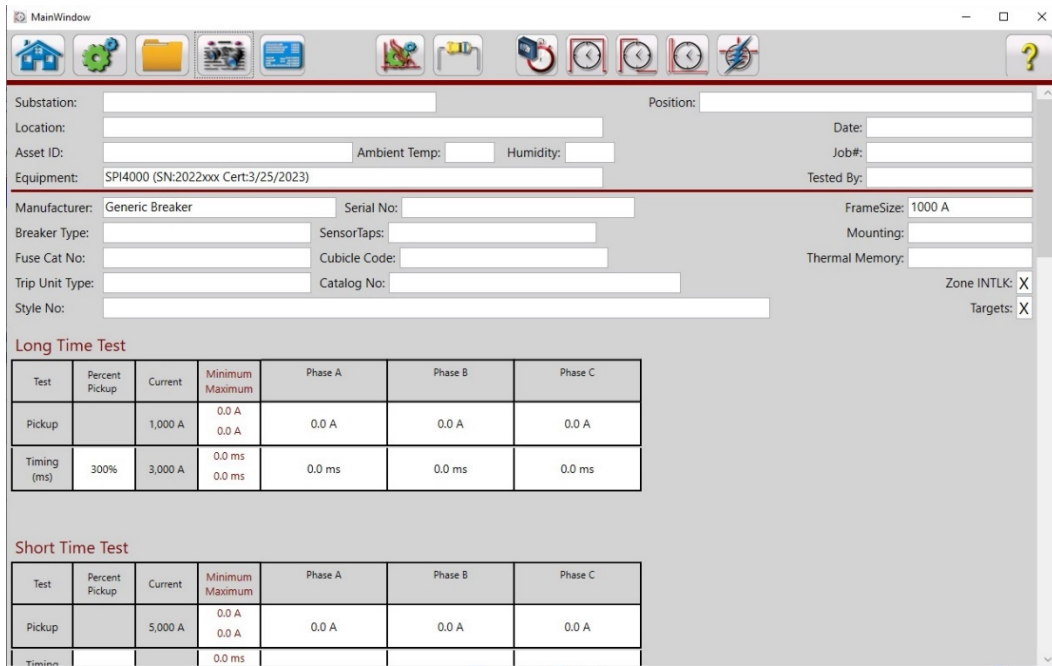

Figure 9 Sample Test Report

When a test is completed the test results will be displayed in the above report.

### 3.3.5 ⑤ Nameplate Data button



Press this button to go to the Nameplate Data entry screen. Here the user can input all the related data associated with the device under test. This information will appear in the Test Result Header, see Figure 5 above.

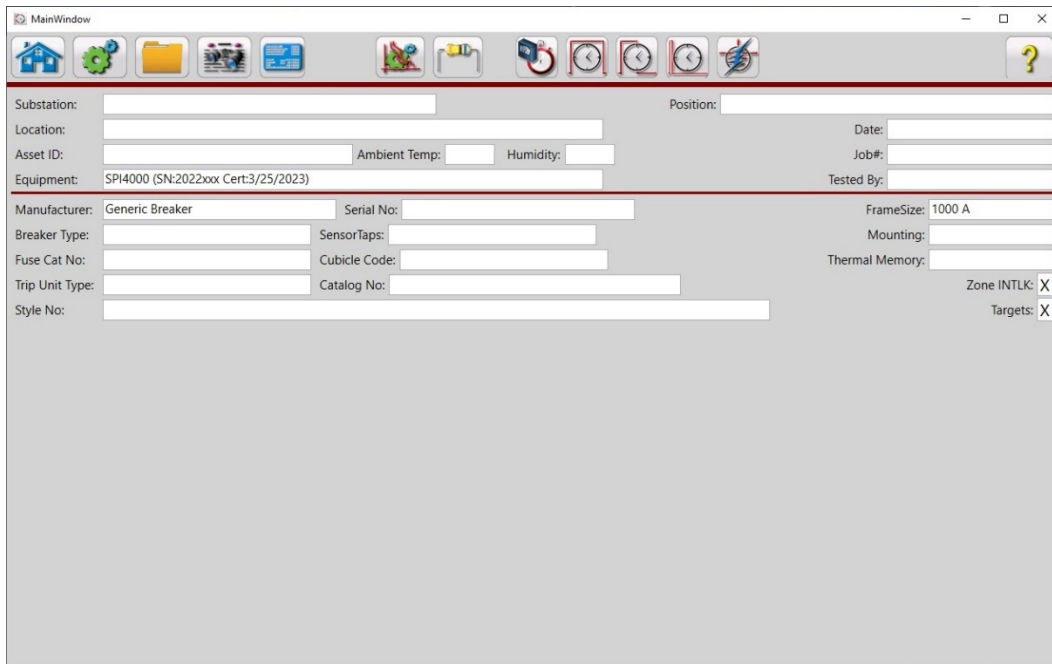

Figure 10 Nameplate Data Screen

### 3.3.6 ⑥ Breaker Settings button



To access the Breaker Settings data window, press this button. Here the user can enter information relative to the device under test such as Pickup and Delay Settings. If the Generic Breaker is selected, only the settings windows will appear. If a specific breaker was selected, then the TCC for that breaker will be included, see the following figure for an example.

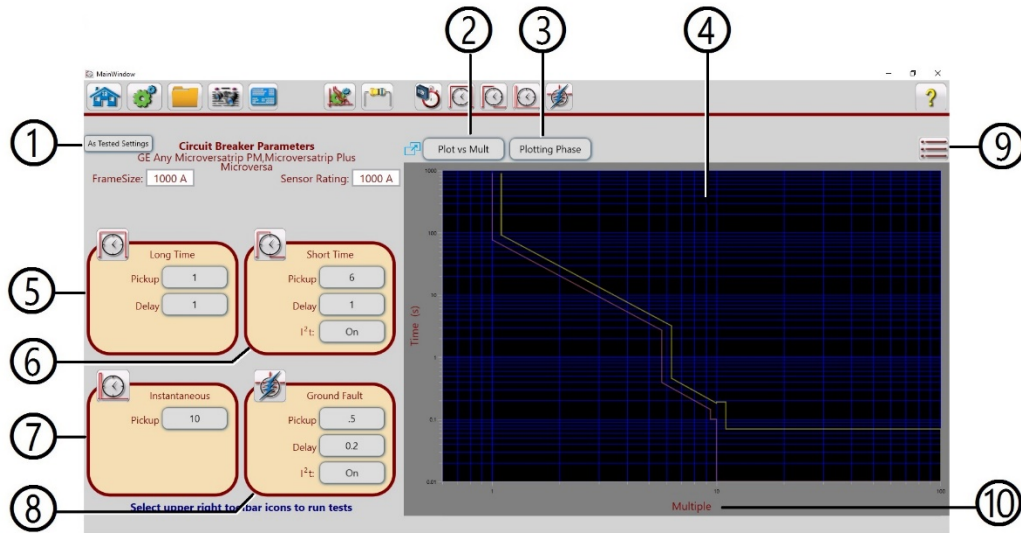

Figure 11 Example Breaker Settings with TCC

#### 3.3.6.1 ① As Tested Settings button

Pressing this button will provide the user with a selection of options regarding how the document will display the settings along with the results, see the following figure.

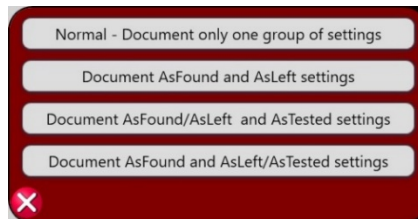

Figure 12 Circuit Breaker Settings Options

##### 3.3.6.1.1 Normal - Document only one group of settings button

Default setting. Only one group of settings will be displayed.

##### 3.3.6.1.2 Document As Found and As Left settings button

Pressing the button will provide two additional buttons; **AsFound** and **AsLeft** just under the Frame Size window. The option is used when changing settings on an in-service breaker. Pressing these buttons, the user can enter the As Found settings, and then change to the As Left settings. The Test Document will include the As Found Settings and the As Left Settings.

##### 3.3.6.1.3 Document As Found / As Left and As Tested settings button

Pressing the button will provide two additional buttons; **AsFound/AsLeft** and **AsTested** just under the Frame Size window. The option is used when changing settings on an in-service breaker. Pressing these buttons, the user can enter the **As Found/As Left** settings and the **AsTested** settings. The Test Document will include the As Found/As Left Settings as well as the As Tested settings.

#### 3.3.6.1.4 Document As Found and As Left/AsTested settings button

Pressing the button will provide two additional buttons; **AsFound** and **AsLeft/AsTested** just under the Frame Size window. The option is used when changing settings on an in-service breaker. Pressing these buttons, the user can enter the **As Found** and **As Left / AsTested** settings. The Test Document will include the As Found and As Left / As Tested settings.

#### 3.3.6.2 ② Plot vs Current button

Pressing this button will toggle between **Plot vs Current** and **Plot vs Multiple**, which will change the X-axis label from **Current (A)** to **Multiple**. Some TCC are plotted in Amperes and some are plotted in Multiples of rating.

#### 3.3.6.3 ③ Plotting Phase button

Pressing this button will toggle between **Plotting Phase** and **Plotting Ground**, which will change the displayed Phase TCC to displaying the Ground TCC.

#### 3.3.6.4 ④ Graphical Display

If using the Manual Control, or the Generic Breaker test functions, a Time Current Curve Characteristic will not be provided. The Graphical display will only appear for selected circuit breakers which have a time curve characteristic in the SPI4000 Library.

#### 3.3.6.5 ⑤ Long Time settings



There are two values to enter, **Pickup** and **Delay**. Pressing the **Pickup** button will provide a listing of typical pickup % values, and Off. Press Off if there is no Long-Time delay setting. If none of the typical values apply, the user can manually enter the pickup value in the **Enter Value** window. Press the green check button when finished. Pressing the **Delay** button will provide three possible Band delay options, **Max, Int, Min**. Press the appropriate Delay Band option associated with the device under test.

#### 3.3.6.6 ⑥ Short Time settings



There are two values to enter, **Pickup** and **Delay**. Pressing the **Pickup** button will provide a listing of typical pickup % values, and Off. Press Off if there is no Short-Time delay setting. If none of the typical values apply, the user can manually enter the pickup value in the **Enter Value** window. Press the green check button when finished. Pressing the **Delay** button will provide three possible Band delay options, **Max, Int, Min**. Press the appropriate Delay Band option associated with the device under test.

#### 3.3.6.7 ⑦ Instantaneous setting



Pressing the Pickup button will display a list of typical Instantaneous multiples, and Off. Press Off if there is no Instantaneous setting. If none of the typical values apply, the user can manually enter the pickup value in the **Enter Value** window. Press the green check button when finished.

#### 3.3.6.8 ⑧ Ground Fault settings



There are two values to enter, **Pickup** and **Delay**. Pressing the **Pickup** button will provide a listing of typical pickup % values, and Off. Press Off if there are no Ground Fault settings. If none of the typical values apply, the user can manually enter the pickup value in the **Enter Value** window. Press the green check button when finished. Pressing the **Delay** button will provide three possible delay Band options, **max, int, min**. Press the appropriate Delay Band option associated with the device under test.

#### 3.3.7.9 ⑨ Special Functions button



Pressing this button provides the following options list.

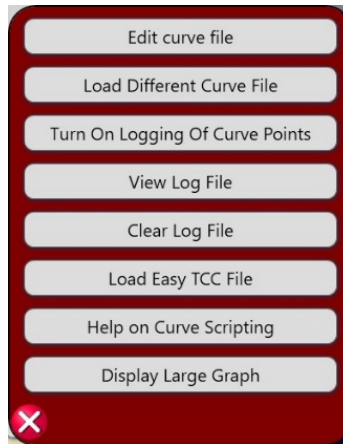

Figure 13 Special Functions Options List

#### 3.3.6.9.1 **Edit Curve file** button

This is for more advanced users/programmers to edit existing curve data. This button will open a visual basic program window where the curve script file may be edited for the circuit breaker that has been selected. Press the **Help on Curve Scripting** button to view the help file associated with defining curves using vbscript.

#### 3.3.6.9.2 **Load Different Curve File** button

This button will open the File Explorer, where the user may select a different curve that has been stored in memory.

#### 3.3.6.9.3 **Turn On Logging of Curve Points** button

The default position is On. Pressing this button will produce a message window stating that the curve data points will not be written to the SPI log file. If there is an issue regarding the data points that needs to be discussed with Megger, this information will be helpful in troubleshooting the issue. Turning the logging of the data points Off will save a little space in memory in your STVI, or PC.

#### 3.3.6.9.4 **View Log File** button

Select this button to view logged commands sent to the SPI4000 unit from the SPI software. This information can be useful to the Megger Technical Support Group when troubleshooting.

#### 3.3.6.9.5 **Clear Log File** button

Select this button to clear the logged commands sent to the SPI4000 unit from the SPI software. When troubleshooting it may be necessary to clear the logged commands.

#### 3.3.6.9.6 **Easy Load TCC File** button

There are two options presented when pressing this button, see the following figure.

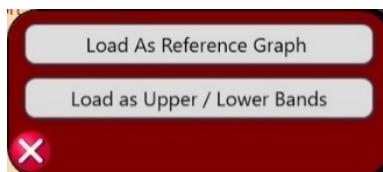

Figure 14 Easy Load TCC Options List

The following are descriptions of each option.

**Load As Reference Graph:** Using a 3<sup>rd</sup> party software program, advanced users can generate Time Curve Characteristics and save to the PC as a graphic file. Pressing this button will provide access to

the saved file to load and use as a reference when conducting pickup and timing tests. Contact Megger Technical Support for more information.

**Load as Upper / Lower Bands:** Using a 3<sup>rd</sup> party software program to generate Time Curve Characteristics, advanced users can overlay those characteristics into the graphic window provided for conducting pickup and timing tests. Contact Megger Technical Support for more information.

**3.3.6.9.7 Help on Curve Scripting button**

This is for more advanced users/programmers. Press this button to review the Curve Scripting Help file.

**3.3.6.9.8 Display Large Graph button**

Pressing this button will enlarge the displayed TCC to full screen. To go back to a normal screen, press the **Special Functions** button and press the **Display Small Graph** button.

**3.3.6.10 ⑩ X-Axis Display Nomenclature**

There are two nomenclatures, **Current** and **Multiple** associated with the TCC. The nomenclature will change with the pressing of the **Plot vs Current** see section 3.3.7.2.

**3.3.7 ⑦ Insulation Contact Resistance button**



Pressing this button will open the Insulation and Contact Resistance input screen, see the following.

Insulation Resistance						
	Phase A (MΩ)		Phase B (MΩ)		Phase C (MΩ)	
	Reading	20°C	Reading	20°C	Reading	20°C
Phase to Phase						
Phase to Frame						
Line to Load						

Contact Resistance (Ω)		
Phase A (μΩ)	Phase A (μΩ)	Phase A (μΩ)

Figure 15 Insulation and Contact Resistance screen

The user can perform insulation and contact resistance tests on the circuit breaker and enter the test data here. This will become part of the test report.

**3.3.8 ⑧ Manual Test button**





Press this button to perform a manual test.



3.3.9 ⑨ **Long Time Test** button   
Press this button to perform a Long Time Delay test.

3.3.10 ⑩ **Short Time Test** button   
Press this button to perform a Short Time Delay test.

3.3.11 ⑪ **Instantaneous Time Test** button   
Press this button to perform an Instantaneous test.

3.3.12 ⑫ **Ground Fault Test** button   
Press this button to perform a Ground Fault test.

3.3.13 ⑬ **Help** button   
Press this button to access the User Guide.

3.3.14 ⑭ **Test** buttons  
Press this button to perform a selected test.

3.3.15 ⑮ **Manual Test** button  
Press this button to access the Manual Test Screen.

3.3.16 ⑯ **Circuit Breaker Library** button  
Press this button to access the time curve database, which includes a library of manufacturers TCC, see the following figure for library options.

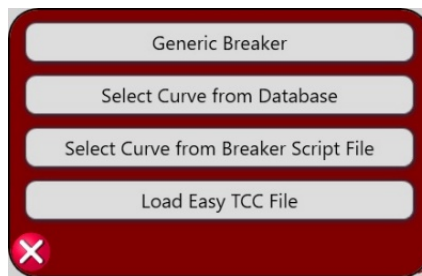

Figure 16 Library Options screen

### 3.4 Configuration of SPI4000 software

This section of the manual includes configuration of the SPI4000 software. The SPI4000 software is the manual control and user interface for the unit. All manual entries will be made through the touch screen of the SPI4000 STVI or through a PC. If using the STVI, to follow along with your unit will require that the unit be powered up, and the Ethernet cable connected to the STVI (the STVI uses Power Over Ethernet, see Section 3.1). Before connecting power to the unit, make sure the Unit POWER ON/OFF Switch is in the OFF position. Connect the unit to an appropriate power source, **connect the safety ground terminal to an appropriate earth ground**, and turn the POWER ON/OFF Switch to ON. The SPI4000 unit will go through its power up sequence, and in less than a minute the main startup screen will appear on the STVI.

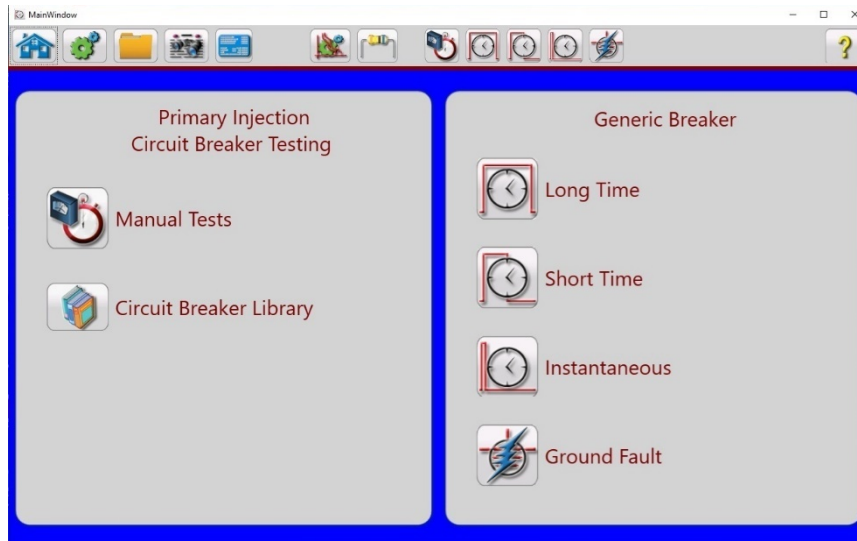



Figure 17 Main startup screen

### 3.4.1 Configuration

Pressing the Configuration button  will allow the user to configure the SPI4000 hardware and SPI4000 software by displaying tabs for; **General** and **System**.

#### 3.4.1.1 General Configuration Options

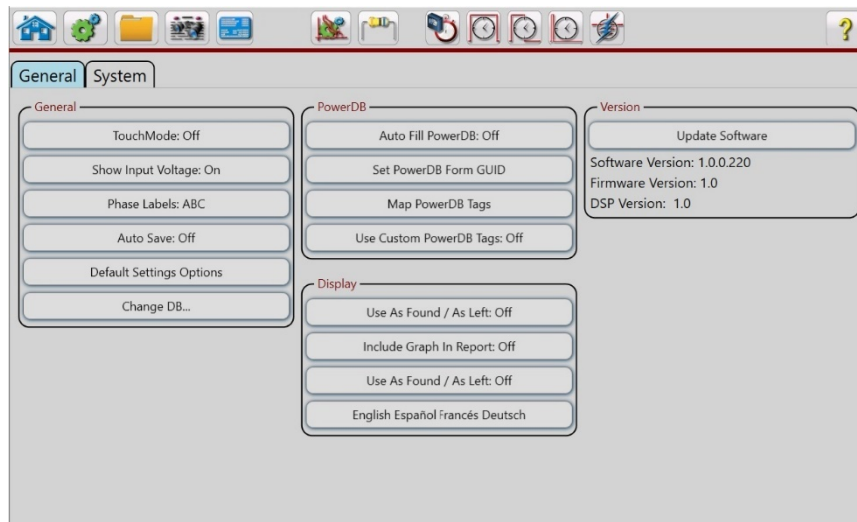

Figure 18 General Configuration Options screen

#### 3.4.1.1.1 General Options Group

##### 3.4.1.1.1.1 TouchMode On/Off

With the TouchMode On, the user can either use the touch screen of the STVI or use a mouse. When in the Off mode, the software will only respond to a mouse click, such as using a PC.

##### 3.4.1.1.1.2 Show Input Voltage On/Off

The user can decide if they want to display the input voltage or not by turning this feature On or Off.

#### 3.4.1.1.1.3 Phase Labels

Found in the System Config General settings section; this button allows the user to set labels for each phase; ABC, RST or 123. Press the default ABC button and two other options appear to select from.

#### 3.4.1.1.1.4 Auto Save

The Auto Save may be turned On or Off. Works similar to auto save features in other software applications, where work will be automatically saved.

#### 3.4.1.1.1.5 Default Settings Options

Press this button to get access to the settings options of Save as Default, Restore Default, and Restore Factory default settings.



Figure 19 Default Settings Options List

#### 1. **Save As Default:**

Press this button and all of the changes made to the Configuration Screen and most of the default values for all screens are now saved as the power up defaults.

#### 2. **Restore Default:**

Pressing this button provides the ability to restore the original system power up defaults.

#### 3. **Restore Factory:**

Pressing this button provides the ability to restore the original system factory power up defaults.

#### 3.4.1.1.1.6 Change DB

Users can change their database if they have PowerDB version 11.2 or higher.

#### 3.4.1.1.2 **PowerDB Options Group**

##### 3.4.1.1.2.1 Auto Fill PowerDB

This is used to populate an open PowerDB test form, while the unit is operating.

##### 3.4.1.1.2.2 Set PowerDB Form GUID

Allows the user to specify the GUID (Global Unique Identifier) of the test form to be used. Normally used by advanced PowerDB users.

##### 3.4.1.1.2.3 Map PowerDB Tags

Allows users to map tests to custom forms. Normally used by advanced PowerDB users.

##### 3.4.1.1.2.4 Use Custom PowerDB Tags

This feature allows the user to use standard tags to map data to a form or to use the custom tag map. Normally used by advanced PowerDB users.

#### 3.4.1.1.3 **Display Options Group**

##### 3.4.1.1.3.1 Use As Found / As Left

Found in the Display Options section, under the General tab in the System Configuration Screen, the button defaults to Off. The user will need to select On if they want As Found/As Left results displayed in the test report.

#### 3.4.1.1.3.2 Include Graph In Report

The user can choose to include the TCC, Time Curve Characteristic, in the test report by clicking on this button changing from the default Off position to On.

#### 3.4.1.1.3.3 English, Español, Francés, Deutsch

Found in General settings; this button allows the user to select the desired displayed language. The factory default is English. Future releases will include Spanish, French and German.

#### 3.4.1.1.4 Version

The version of software, firmware and DSP version are shown in the window. To Update the Software, press the **Update Software** button. When the button is pressed it will look for new versions of software. If one is found it will step you through the process of updating the STVI and the firmware in the unit. See section 6.3 **Updating SPI4000 firmware and software** for more instructions.

### 3.4.1.2 System Configuration Options

This section of the manual will describe the System Group, Timer Group, and Ethernet configurations in the SPI4000 software.

#### 3.4.1.2.1 System Group

The System Group includes information related to the test system inputs and output, including internal temperature.

##### 3.4.1.2.1.1 Line Frequency

The test system measures and displays the input line frequency and displays it in the Configuration / System Group window.

##### 3.4.1.2.1.2 Internal Temperature

The test system constantly measures the internal temperature in order to protect the unit against thermal damage. The internal temperature can be viewed in the SPI4000 Configuration / System Group window.

##### 3.4.1.2.1.3 Running on 480 (or 240) VAC Input

There are two buttons, 480 and 240 Volt. The unit defaults to 480 volts. In the 480V mode, the unit auto senses and can run on any input voltage down to 260 volts, with possible limitations. Running in 240V mode changes the way the input windings are connected. If the input voltage is below 260V, it will allow the user to change the unit to the 240V mode by pressing the 240V button.



**APPLICATION NOTE:** With the selection of the 240 Volt Mode, with a 240-volt input the unit will produce ½ of rated output.

##### 3.4.1.2.1.4 Adjust Current During Timing

By default, the SPI4000 will automatically adjust current to maintain the setpoint during timing test. Turning this function Off the unit will not automatically adjust the output current for the duration of the test.



**APPLICATION NOTE:** Normally, as the breaker heats up the output has to be raised to keep the same current due to heat and resistance increasing. It is recommended to leave this feature On. However, for special cases the user can turn off the auto adjust by pressing this button.

##### 3.4.1.2.1.5 Series Mode

When connecting the output terminals into series mode, the System Series Mode configuration must be placed in the On Mode to properly measure the output current.



**APPLICATION NOTE:** See section 3.2.5.1 Selection of Output Connections regarding operation of the SPI4000 using Series Connections.

#### 3.4.1.2.1.6 Calibrate Unit

 **NOTE:** Only qualified personnel should calibrate the unit. Contact Megger Dallas or your local Megger representative for more information.

#### 3.4.1.2.2 Timer Group

##### 3.4.1.2.2.1 Timer Unit

The user can select to display trip time either in seconds or cycles by pressing this button. The default position is seconds. Cycles is based on 50 or 60 hertz depending on the frequency of the input voltage.

##### 3.4.1.2.2.2 Stop On Options

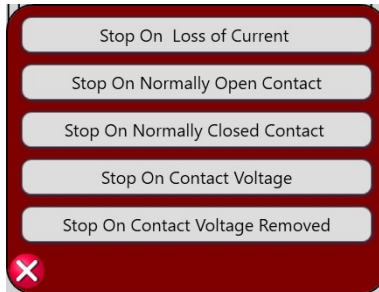

Figure 20 Timer Stop Options List

#### 1. Stop On Loss of Current

Timer will initiate only when the output circuit is completed, and a threshold current of approximately 10% of the selected test current is exceeded. Timer will continue to run until output circuit opens, and the current drops below threshold level, or output is de-energized by the user.

#### 2. Stop On Normally Open Contacts (closing)

With the BINARY INPUT terminals connected to normally open external contacts, output circuit will remain energized and timer will continue to run until contacts close.

#### 3. Stop On Normally Closed Contacts (opening)

With the BINARY INPUT terminals connected to normally closed external contacts, output circuit will remain energized and timer will continue to run until contacts open.

#### 4. Stop On Contact Voltage (applied)

With the BINARY INPUT terminals connected to an external monitoring circuit, output circuit will remain energized and timer will continue to run until an AC or DC Voltage is applied.

#### 5. Stop On Contact Voltage Removed

With the BINARY INPUT terminals connected to an external monitoring circuit, output circuit will remain energized and timer will continue to run until an AC or DC Voltage is removed.

##### 3.4.1.2.2.3 Firing Angle

The firing angle will limit inrush current and DC offset on the output. The default is 70 degrees and this angle can be adjusted if different types of loads are tested with the unit. If large DC components are measured on the output this angle can be changed to get the best results. For normal breaker testing this setting should not be adjusted. Any changes to this value will be erased and default back to 70 on a power cycle of the unit.

#### 3.4.1.2.3 Ethernet

The STVI or PC will auto-detect the SPI4000 unit (the DHCP mode does not require the user to input an IP address). If the unit is on a network with a DHCP server, the user must enter an IP address. Using the STVI or PC, pressing the DHCP button will highlight the Static IP Address Dialog box where the user can enter the IP address.



**NOTE:** On the PC version, the PC might not auto detect due to firewall or VPN settings. In this case the firewall can be temporarily turned off.

#### 4.0 Operating Instructions

The **Manual Test** section is designed for general purpose high current test applications or primary current tests such as motor overload relays etc. This section describes basic operating procedures for using the SPI software and hardware for such applications as basic pickup and timing tests. The **Advanced Test** section is designed for automated testing of devices using the built-in tests associated with low voltage circuit breakers using manufacturers Time Current Curves.

#### 4.1 Safety Considerations



**DANGER:** Professional organizations using this unit will normally have safety procedures covering such installations and users will be trained to follow them. Notwithstanding these conditions, certain precautions should be followed when using this unit.

1. The chassis ground connection should **always** be firmly attached to the system ground bus.
2. Connections should be established to the current terminals before the unit is energized.

#### 4.2 Set up of SPI4000

##### 4.2.1 Unpack System

Unpack the unit and check the instrument and accessories for evidence of any shipping damage. If there is any visual damage, immediately notify the freight carrier to make a damage claim, and notify Megger of the damage. If no damage, **save the shipping box and packing material for reuse**; such as returning the unit for calibration certification. If being returned for calibration or service, see section 10.2 Return Procedure.

##### 4.2.2 Initial startup



**DANGER:** ALL SAFETY PROCEDURES AND PRECAUTIONS MUST BE FOLLOWED WHEN OPERATING THIS UNIT!

1. Before connecting power to the unit, make sure the Unit POWER ON/OFF Circuit Breaker is in the OFF position.
2. Connect the power cables into an appropriate power source, connect the safety ground to an appropriate earth ground, and turn the POWER ON/OFF Circuit Breaker to ON. The SPI4000 unit will go through its power up sequence. If using the optional STVI, in less than a minute the main startup screen will appear, see section 4.3.

#### 4.3 Main Startup Screen

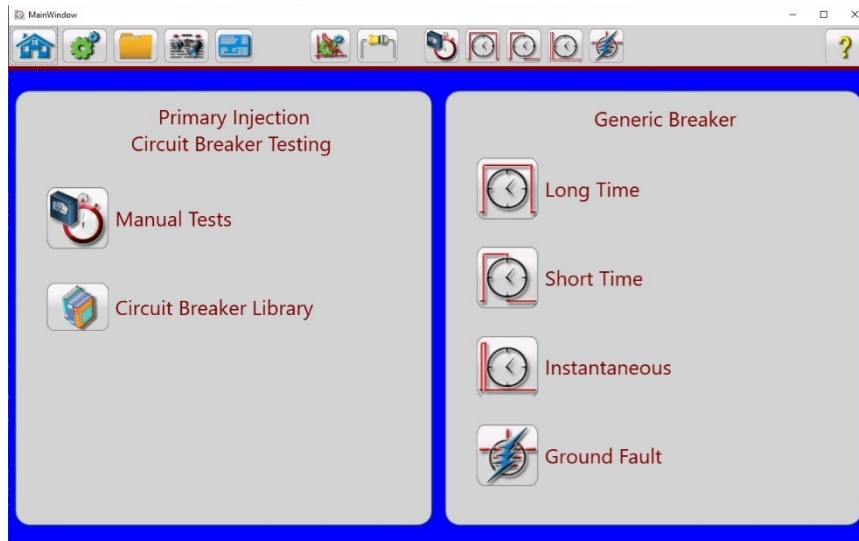



Figure 21 Main Startup Screen

#### 4.3.1 Manual Test

To perform a manual test, in the Main Startup screen press on the Manual Test button . The following screen will appear.

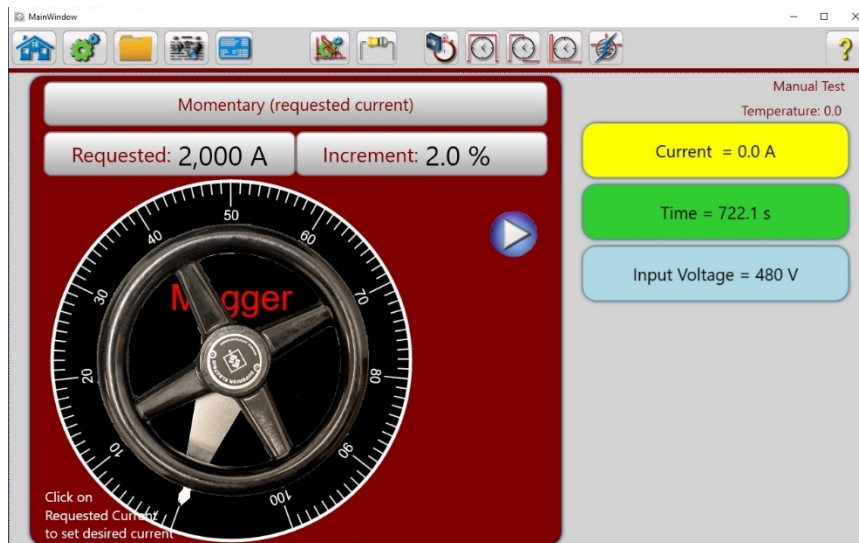

Figure 22 Manual Test Screen, Momentary requested current

#### 4.3.2 Manual Modes of Operation

There are four options available. Pressing the Momentary (requested current) button will display the following figure.



Figure 23 Manual Modes of Operation

#### 4.3.2.1 Momentary (0% to 100% output power)

Clicking on the Momentary (0% to 100% output power) button will present the following screen.

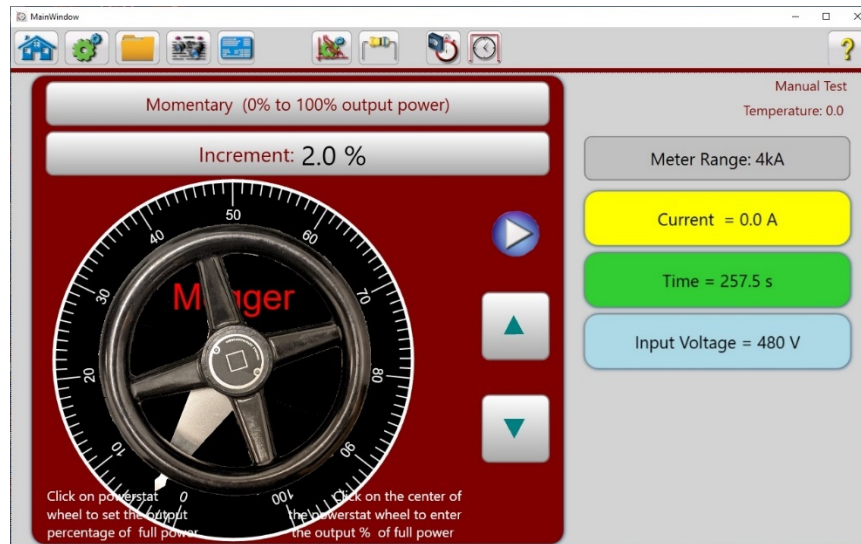



Figure 24 Manual Momentary 0 to 100% output power Test Screen

In this mode the unit will perform a momentary bump of current when the blue play button  is pressed. Output of the unit will be based on the wheel setting, which is 0 to 100% of full output power. Click on the Powerstat™<sup>1</sup> wheel to set an output level, then press the blue play button. A graphic display will show the user the % of Output current based upon the position of the wheel and the **Maximum Current Safety Limit** level entered by the user. A duration time that the current will be applied defaults to 8.0 Cycles, but can be changed by the user, see the following figure.

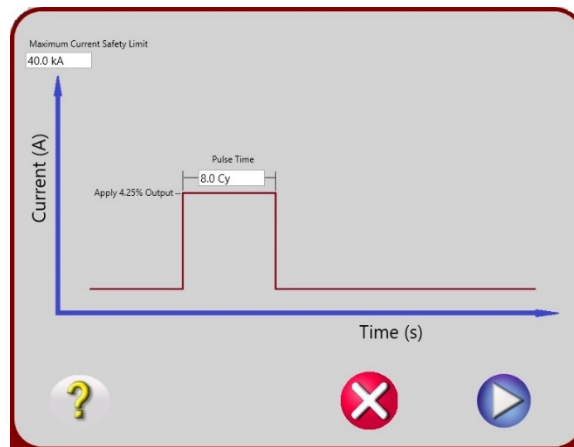

Figure 25 Momentary Pulse Input Screen



**APPLICATION NOTE:** In the above figure the **Maximum Current Safety Limit** is set to 40.0 kA and the **Pulse Time** is set to 8.0 Cycles. With the control wheel adjusted to 5.16% of the Maximum Output setting, depending on the load impedance, the expected test current should be a little more than 2,000 Amps.

<sup>1</sup> Powerstat is a registered Trade Mark by Superior Electric



Pressing the blue play button will produce the 8 cycles of test current. The output current will be displayed in the **Current** window. Once current is produced the user can use the up/down ▲▼ arrows to bump the current up or down until the desired current is found. Note that the default adjustment of the current using the up/down arrows is 2.0%. Press the **Increment Percent** button and a numerical keypad will appear to enter a higher or lower % value for finer adjustment.

#### 4.3.2.2 Continuous (0% to 100% output power)

In this mode the unit will perform a continuous output until the breaker trips (or preset **Max Time** limit is reached). Typically, a user will use Momentary (0% to 100% output power) to find the proper test current, then switch to Continuous mode to run a test. Pressing the Momentary (requested current) will produce the **Manual Modes Options** screen, see figure 23. Select the Continuous (0% to 100% output power) option, the following figure will appear.

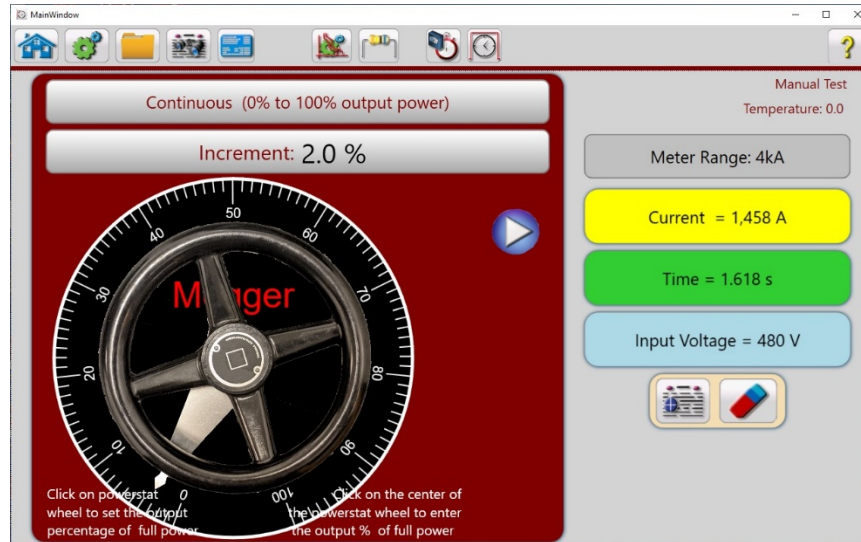

Figure 26 Manual Test Continuous 0 to 100% output power

Pressing the blue play button will provide a graphic display showing the user the **% of Output** based upon the position of the wheel and the **Maximum Current Safety Limit** level entered by the user. A **Max Time** duration that the current will be applied defaults to 150 s (seconds), but can be changed by the user, see the following figure.

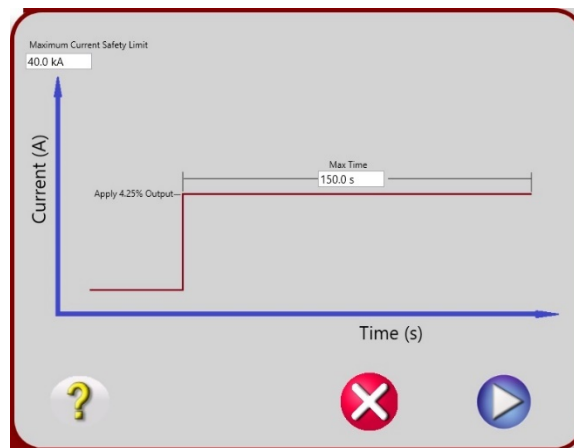

Figure 27 Continuous Mode Input Screen



**APPLICATION NOTE:** In the above figure the **Maximum Current Safety Limit** is set to 40.0 kA Amps and the **Max Time** is set to 150 seconds. The control wheel was adjusted to 5.16% of the Maximum Output setting. At 5.16%, depending upon the load impedance, the expected test current should be a little more than 2,000 Amps.

Pressing the blue play button will produce 150 seconds of test current. The output current will be displayed in the **Current** window.

#### 4.3.2.3 Momentary (requested current)

Clicking on the **Momentary (requested current)** button will present the following screen.



Figure 28 Momentary (requested current) test screen

This mode allows the user to set a desired test current by pressing the **Requested** button and using the pop-up numerical keypad type in a **Requested Current** value. If using the PC version, click in the **Requested Current** window and use the PC numeric keys to enter the desired output current value. Press the blue play button and the following figure will appear.

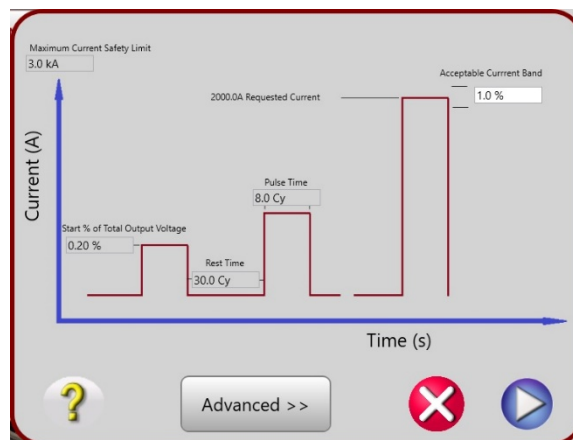

Figure 29 Momentary Requested Current Setting Screen

When the blue play button is pressed in the above figure, the unit will pulse current until the desired current is found, then it will momentarily run the desired current for the amount of time requested (typically cycles) or until the breaker trips.



**APPLICATION NOTE:** In the above figure the **Maximum Current Safety Limit** is set to 3.0 kA. The **Requested Current** was set to 2000.0 Amps, with an **Acceptable Current Band** of 1.0%. Note that when the blue play button is pressed the output will go through a set of short pulses of current automatically incrementing the output current in steps until the **Requested Current** value is reached. The output will initially start at a setting value of 0.20% of the **Maximum Current Safety Limit** setting, with a **Pulse Time** on for the 8.0 Cycle setting, and a **Rest Time** setting between pulses of 30.0 Cycles.

#### 4.3.2.4 Continuous (requested current)

Clicking on the **Continuous (requested current)** button will present the following screen.

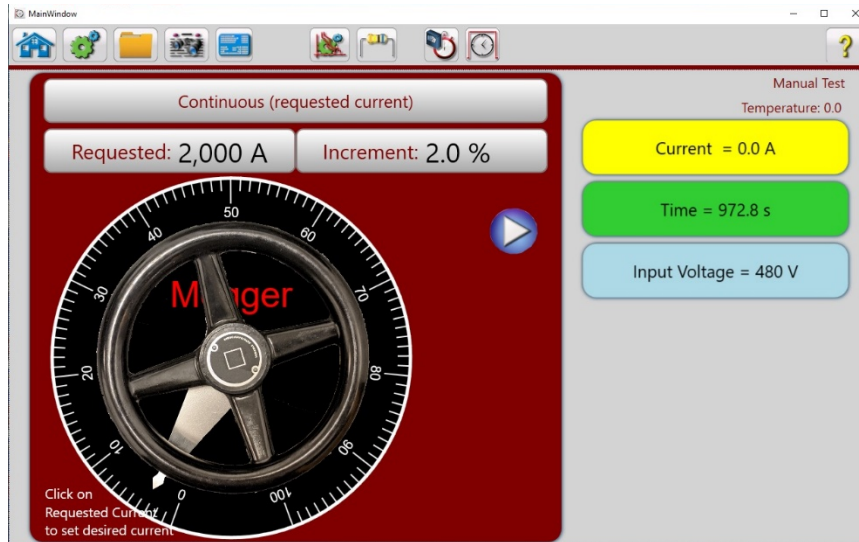

Figure 30 Continuous requested current test screen

This mode allows the user to set a requested test current by pressing the **Requested current** button in the **Manual Test** screen, and using the pop-up numeric keypad enter a current value. If using the PC version, click in the **Requested current** window and use the PC numeric keys to enter the desired output current value. Press the blue play button and the following figure will appear.

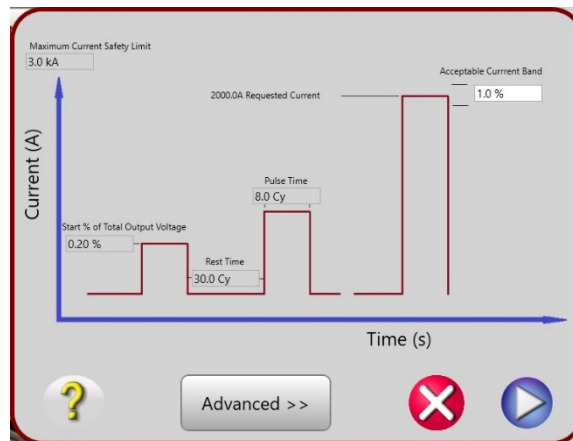

Figure 31 Continuous Requested Test Current Setting Screen

When blue play button is pressed in the above figure, the unit will pulse current until the desired current is found, then it will continuously run the desired current for the **Max Time** setting (typically seconds) or until the breaker trips.



**APPLICATION NOTE:** In the above figure the **Maximum Current Safety Limit** is set to 3.0 kA. The **Requested current** was set to 2000.0 Amps, with an **Acceptable Current Band** of 1.0%. Note that when the blue play button is pressed the output will go through a set of short pulses of current automatically incrementing the output current in steps until the **Requested current** value is reached. The output will initially start at a setting value of 0.20% of the **Maximum Current Safety Limit** setting, with a **Pulse Time** on for the 8.0 Cycle setting, and a **Rest Time** setting between pulses of 30.0 Cycles Once the **Requested** current value is reached, the unit wait a **Preset Time** (defaulted to 2 seconds), before turning back on and applying the test current. The requested test current will stay on for the **Max Time** setting or the breaker trips, whichever comes first. To change the **Maximum Current Safety Limit**, **Start %**, **Rest**, or **Pulse Time** settings, press the **Advanced** button.

### 4.3.3 Advanced Automated Test

#### 4.3.3.1 Selecting a Curve

To perform an advanced automated test, in the Main Startup screen press on the **Circuit Breaker Library** button  The following screen will appear.

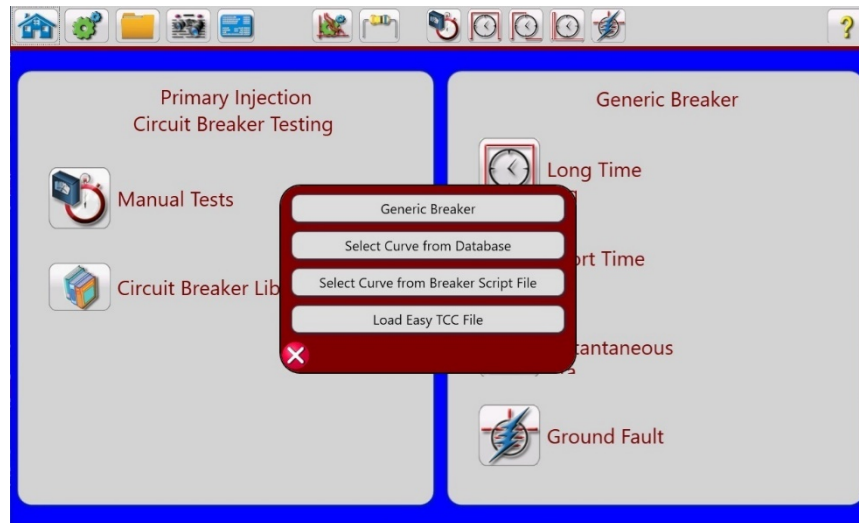

Figure 32 Circuit Breaker Library Option Selected

#### 4.3.3.2 Selecting Generic Breaker

Click on Generic Breaker and the following screen will appear.

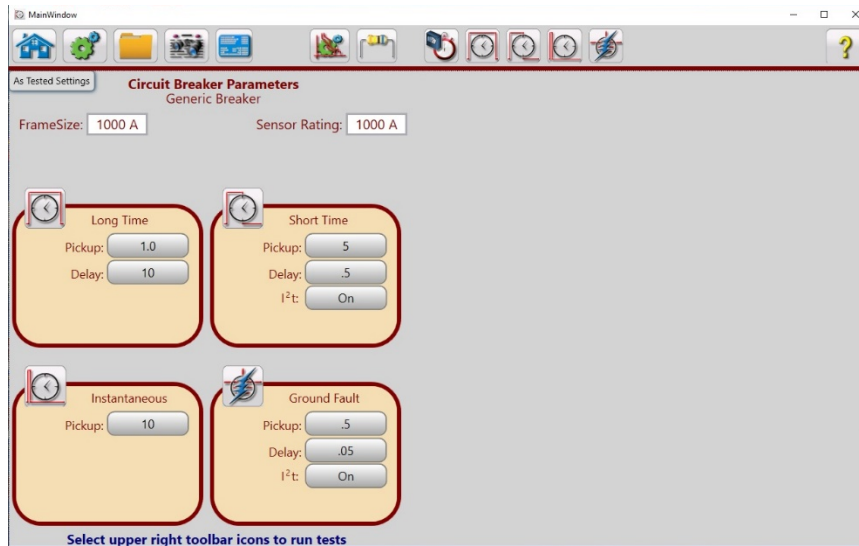



Figure 33 Generic Breaker Setting Screen

Enter the **Frame Size** and **Sensor Rating** in the windows provided. Enter the appropriate breaker setting values for **Long Time**, **Short Time**, **Instantaneous**, and **Ground Fault**. To execute the individual tests, click on the appropriate test icon in the tool bar. For example, pressing the **Long**

**Time Test**  icon for the above setting values will result in the following figure.

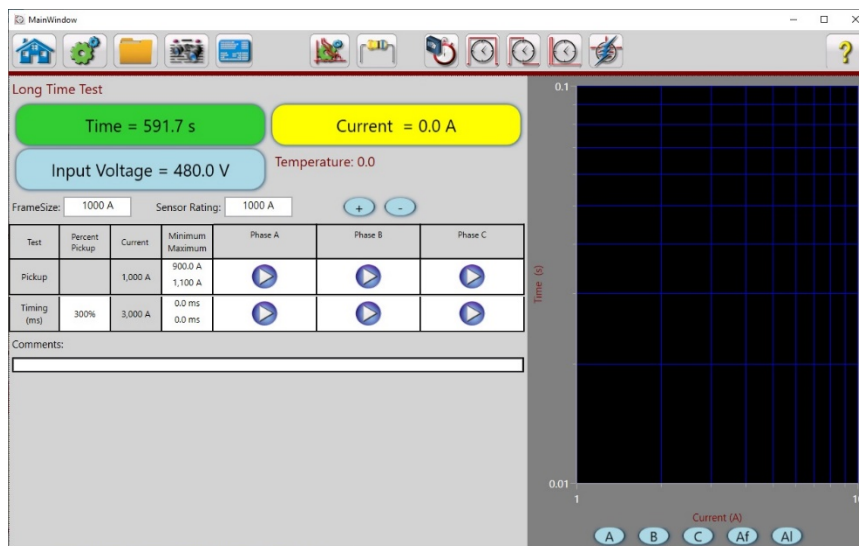

Figure 34 Example Generic Long Time Test Screen

To perform a Generic **Long Time Pickup** test, click on the blue play button for Phase A Pickup test will provide the following figure.



Figure 35 Example Generic Long Time Pickup Test Description

Any of the white boxes can have the values changed, but in most cases the defaults are sufficient. These include:

- **Maximum Current** – Limits the test set to how high current can go during the test. This is a safety feature if desired.
- **Start% of Output** – This is the level of output (in % of transformer) that the test will start at. The unit pulses current (based on Pulse Time) and measures the amount of current applied to the output. The unit uses this feedback to approximate the desired current and applies another pulse. It will do this several times until the desired start current is reached.
- **Rest Time** – This is the rest time between search pulse.
- **Pulse Time** – This is how long the search pulse last.
- **Start Percent** – This is the percent of LT Pickup that you want to start the test at. Typically, 80% is an acceptable level to start looking for LT Pickup. The unit will do several search pulses until this level is found. Then it will start the test.
- **Acceptable Current Band** – This is the amount of error accepted when finding the starting current for the test.
- **Percent Increment** – This is the amount of current the unit will increment as the current ramps up looking for Pickup.
- **Ramp Pulse Time** – This is the amount of time between ramps during the Pickup Test.

To run the test, press the blue play button and the unit will find the start current and then ramp the current up, per the settings. Once the **Pickup Light** on the breaker lights up, press the **Simulate Breaker Trip** button to record the value. Also, note that the Minimum and Maximum pickup values are pulled from the Test Screen. If higher or lower values are desired, click in the Minimum and Maximum values in the window and a numeric keyboard will appear.

To perform a Generic **Long Time Timing Test**, press the blue Play button in the **Timing** row under the **Phase** that is desired to be tested. The setting screen shown in the figure below will appear.



Figure 36 Example Generic Long Time Timing Test Description

The default values in this screen will work for most testing, but any value in the white boxes can be changed. These include:

- **Maximum Current** – Limits the test set to how high current can go during the test. This is a safety feature if desired.
- **Start% of Output** – This is the level of output (in % of transformer) that the test will start at. The unit pulses current (based on Pulse Time) and measures the amount of current applied to the output. The unit uses this feedback to approximate the desired current and applies another pulse. It will do this several times until the desired start current is reached.
- **Rest Time** – This is the rest time between search pulse.
- **Pulse Time** – This is how long the search pulse last.
- **Acceptable Current Band** – This is the amount of error accepted when finding the starting current for the test.
- **Pretest Time** – This is the amount of time the test set waits between finding the desired current and running the test. This time gives the breaker a chance to cool for more accurate testing, and can be changed to any value desired.
- **Max Time** – This is the max time the test set will perform the test. For most breakers 150 seconds is more than enough time to operate the breaker. If a breaker is being tested that has a longer trip time, this can be adjusted in the window provided.

Once the settings are ready, press the blue play button. The test set will search for the desired current and then rest for the **Pretest** time. Then the test set will apply the desired current until the breaker trips, or the **Max Time** limit is reached. It will record the trip time. Note that the Minimum and Maximum delay times default to 0.0 ms. Click on the Minimum and Maximum values in the window and a numeric keyboard will appear. Enter the appropriate minimum and maximum times for the breaker being tested. Normally, Long Time Delay values are measured in seconds. Click on the milliseconds, **ms**, in the numeric keypad window and three selections will be provided, **s** (seconds), **ms** (milliseconds), and **cy** (cycles). Select and enter the appropriate values.

#### 4.3.3.3 Selecting a Curve from Database

Click on **Select a Curve from Database** to view all available manufacturers curves. There are two types of breakers with manufacturers curves that are available, Air Frame and Molded Case. The **Breaker Type** defaults the **Air Frame**. If the breaker to be tested is a Molded Case breaker click on the **Breaker Type Air Frame** button, and the following list will be provided.



Figure 37 Breaker Type Options

Click on **Molded Case** and the following Manufacturers Options window will appear.



Figure 38 Molded Case Breaker Manufacturers List

Select from the available manufacturers. If the manufacturer for your breaker does not exist go back and use the **Generic Breaker**. New manufacturers TCC's will be added to the software from time to time. Check with your Megger sales representative regarding additional breaker TCC's, or check the Megger website to see if a new version of software is available to download, see section 5.3 for more information.

To access manufacturers time curves for **Air Frame** breakers, click on the **Curve Manufacturer Generic Breaker** button and the following Manufacturers Options window will appear.

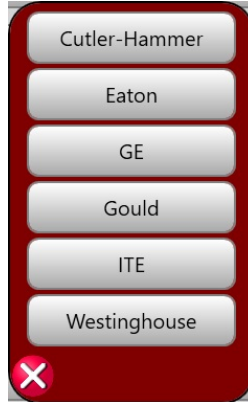

For this example, Air Frame, Square D breaker was selected, see the following figure.



Breaker Type:

Curve Manufacturer:

Curve Family:

Curve Model:

Curve Trip Unit:

Curve Name:

Figure 39 Example Square D Air Frame Breaker

Click on the green check button and the following breaker setting screen will appear.

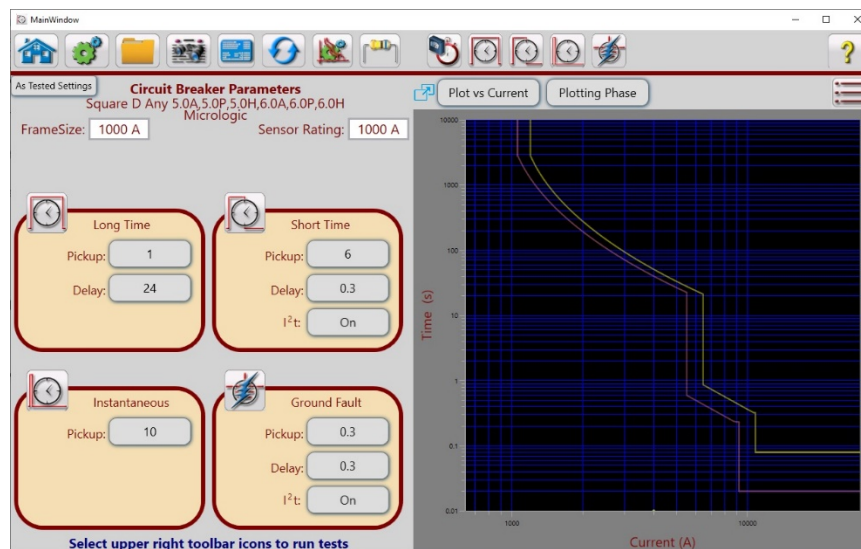





Figure 40 Example Square D Breaker Settings Screen

#### 4.3.3.4 Selecting Tests

In the above example, the breaker has Long Time delay settings, Short Time delay settings, an Instantaneous setting, and Ground Fault settings. The top tool bar allows you to go to several

different element testing modes. These include Long Time Pickup and Timing ,

Short Time Pickup and Timing ,

Instantaneous Pickup and time , and Ground Fault Pickup and Time . Review section 3.3.7 for details regarding Breaker Settings and Tests descriptions.

##### 4.3.3.1.1 Long Time Tests

There are two types of tests for Longtime. **LT Pickup** and **LT Timing**. The software defaults to timing at 300% of LT Pickup, but this can be modified to any value desired by the user. Also, additional timing tests can be added by click the “+” button next to the sensor rating. See figure below.

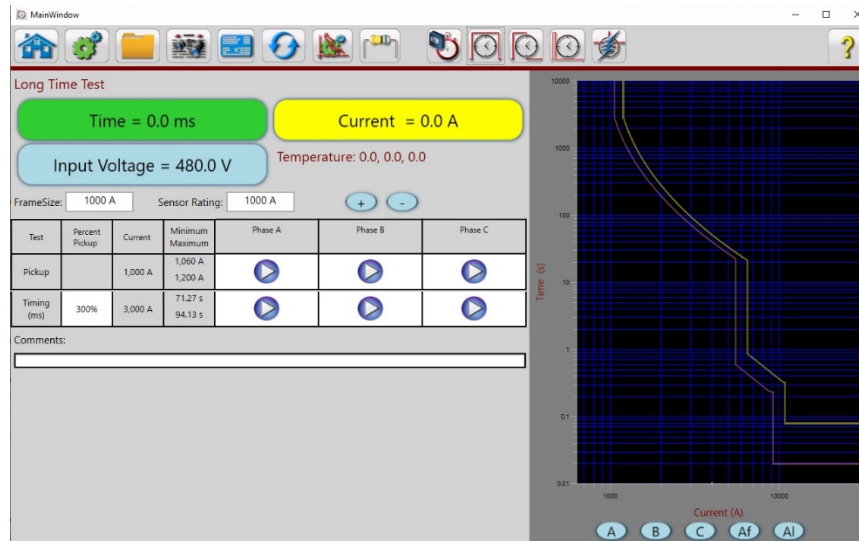

Figure 41 Example Long Time Test Screen

To perform a **LT Pickup**, press the blue play button in the **Pickup** row under the **Phase** desired to be tested. Then a screen will appear showing the details of the test. See figure below.

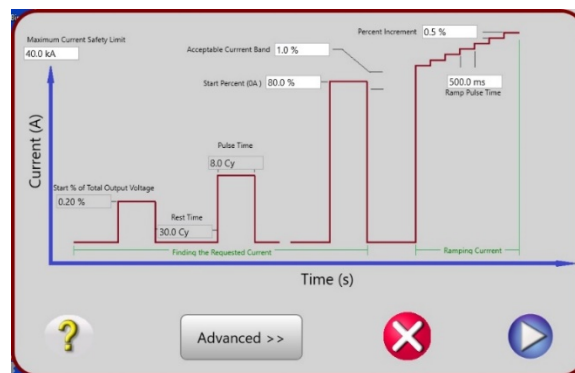

Figure 42 Example Long Time Pickup Test Description

Any of the white boxes can have the values changed by pressing the Advanced button, but in most cases the defaults are sufficient. These include:

- **Maximum Current** – Limits the test set to how high current can go during the test. This is a safety feature if desired.
- **Start % of Output** – This is the level of output (in % of transformer) that the test will start at. The unit pulses current (based on Pulse Time) and measures the amount of current applied to the output. The unit uses this feedback to approximate the desired current and applies another pulse. It will do this several times until the desired start current is reached.
- **Rest Time** – This is the rest time between search pulse.
- **Pulse Time** – This is how long the search pulse last.
- **Start Percent** – This is the percent of LT Pickup that you want to start the test at. Typically, 80% is an acceptable level to start looking for LT Pickup. The unit will do several search pulses until this level is found. Then it will start the test.
- **Acceptable Current Band** – This is the amount of error accepted when finding the starting current for the test.
- **Percent Increment** – This is the amount of current the unit will increment as the current ramps up looking for Pickup.
- **Ramp Pulse Time** – This is the amount of time between ramps during the Pickup Test.

To run the test, press the blue play button and the unit will find the start current and then ramp the current up, per the settings. Once the **Pickup Light** on the breaker lights up, press the **Simulate Breaker Trip** button to record the value. Also, note that the Minimum and Maximum pickup values are pulled from the curve data.

To perform a **LT Timing Test**, press the blue Play button in the **Timing** row under the **Phase** that is desired to be tested. The setting screen shown in the figure below will appear.



Figure 43 Example LT Timing Test Description

Any of the white boxes can have the values changed by pressing the Advanced button, but in most cases the defaults are sufficient. These include:

- **Maximum Current** – Limits the test set to how high current can go during the test. This is a safety feature if desired.
- **Start% of Output** – This is the level of output (in % of transformer) that the test will start at. The unit pulses current (based on Pulse Time) and measures the amount of current applied to the output. The unit uses this feedback to approximate the desired current and applies another pulse. It will do this several times until the desired start current is reached.
- **Rest Time** – This is the rest time between search pulse.
- **Pulse Time** – This is how long the search pulse last.
- **Acceptable Current Band** – This is the amount of error accepted when finding the starting current for the test.
- **Pretest Time** – This is the amount of time the test set waits between finding the desired current and running the test. This time gives the breaker a chance to cool for more accurate testing, and can be changed to any value desired.
- **Max Time** – This is the max time the test set will perform the test. For most breakers 150 seconds is more than enough time to operate the breaker. If a breaker is being tested that has a longer trip time, this can be adjusted.

Once the settings are ready, press the blue play button. The test set will search for the desired current and then rest for the **Pretest** time. Then the test set will apply the desired current until the breaker trips, or the **Max Time** limit is reached. It will record the trip time. Note that the minimum and maximum delay times are shown based on the curve data. A point is also plotted on the curve where the breaker tripped.

#### 4.3.3.4.2 Short Time Tests

There are two types of tests for Short Time; **ST Pickup** and **ST Timing**. The software defaults to timing at 133% of Pickup, but this can be modified to any value desired by the user. Also, additional timing tests can be added by click the “+” button next to the sensor rating. See figure below.

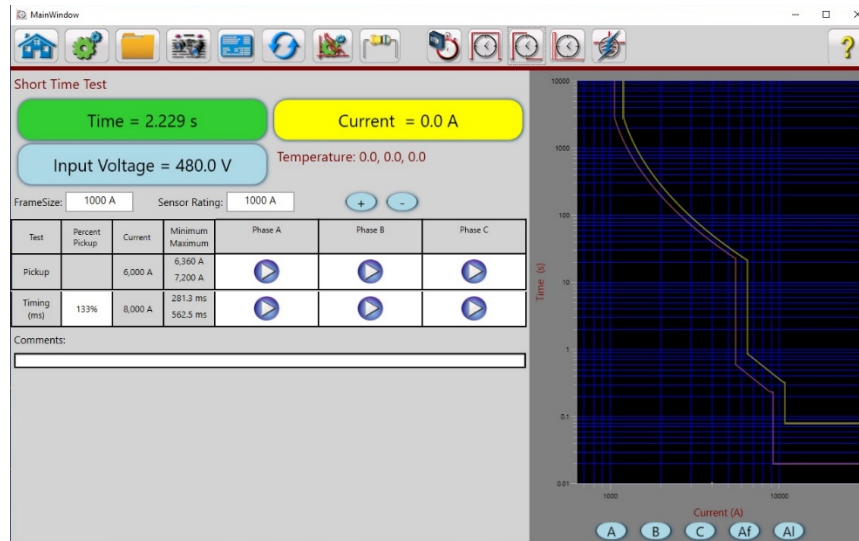

Figure 44 Example Short Time Test Screen

To perform a **ST Pickup**, press the play button in the **Pickup** row under the **Phase** desired to be tested. Then a screen will appear showing the details of the test. See figure below.

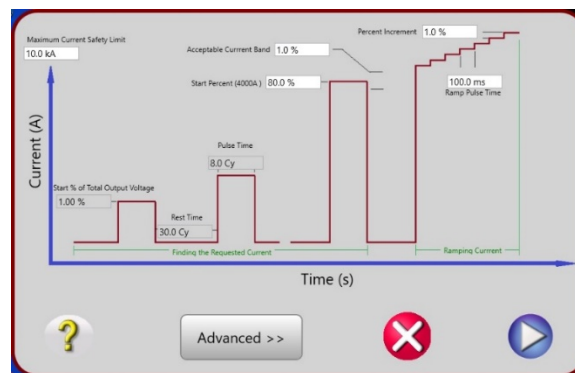

Figure 45 Example Short Time Pickup Test Description

Any of the white boxes can have the values changed by pressing the Advanced button, but in most cases the defaults are sufficient. These include:

- **Maximum Current** – Limits the test set to how high current can go during the test. This is a safety feature if desired.
- **Start% of Output** – This is the level of output (in % of transformer) that the test will start at. The unit pulses current (based on Pulse Time) and measures the amount of current applied to the output. The unit uses this feedback to approximate the desired current and applies another pulse. It will do this several times until the desired start current is reached.
- **Rest Time** – This is the rest time between search pulse.
- **Pulse Time** – This is how long the search pulse last.
- **Start Percent** – This is the percent of LT Pickup that you want to start the test at. Typically, 80% is an acceptable level to start looking for LT Pickup. The unit will do several search pulse until this level is found. Then it will start the test.
- **Acceptable Current Band** – This is the amount of error accepted when finding the starting current for the test.
- **Percent Increment** – This is the amount of current the unit will increment as the current ramps up looking for Pickup.

- **Ramp Pulse Time** – This is the amount of time the pulse will be applied. Note that the unit looks at the max time in the Short Time curve and applies pulses for 135% of the max time. This ensures the pulses are long enough to trip Short Time.

To run the test, press the Blue Play button and the unit will find the start current and then ramp the current up, per the settings. The unit will apply pulses long enough to trip the ST element and keep increasing current until the breaker trips. The unit will record the trip current when the breaker trips.

To perform a **ST Time Delay test**, press the blue play button in the **Timing** row under the **Phase** that is desired to be tested. The setting screen shown in the figure below will appear.

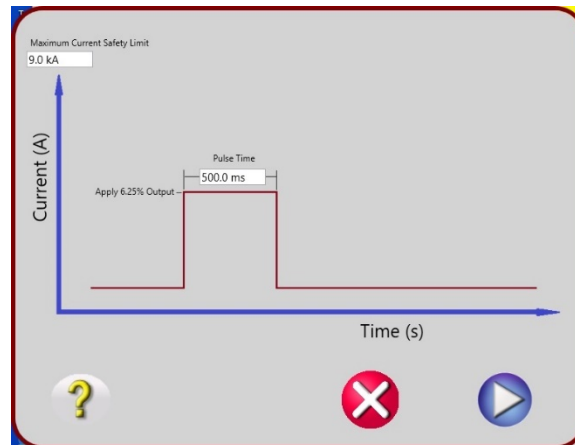

Figure 46 Example ST Timing Test Description

Any of the white boxes can have the values changed by clicking in the window, but in most cases the defaults are sufficient. These include:

- **Maximum Current** – Limits the test set to how high current can go during the test. This is a safety feature if desired.
- **Pulse Time** – This is how long the pulse will last. The pulse time will default to 135% of the max curve time.

Once the settings are ready press the blue play button. The test set will apply the desired current. It will calculate the current needed based on the ST Pickup test that was done. The test set will record the time it takes to trip the ST element.

#### 4.3.3.4.3 Instantaneous Tests

There are two types of tests for Instantaneous, **Inst Pickup** and **Inst Timing**. The software defaults to timing at 110% of Pickup, but this can be modified to any value desired by the user. Also, additional timing tests can be added by click the “+” button next to the sensor rating. See figure below.

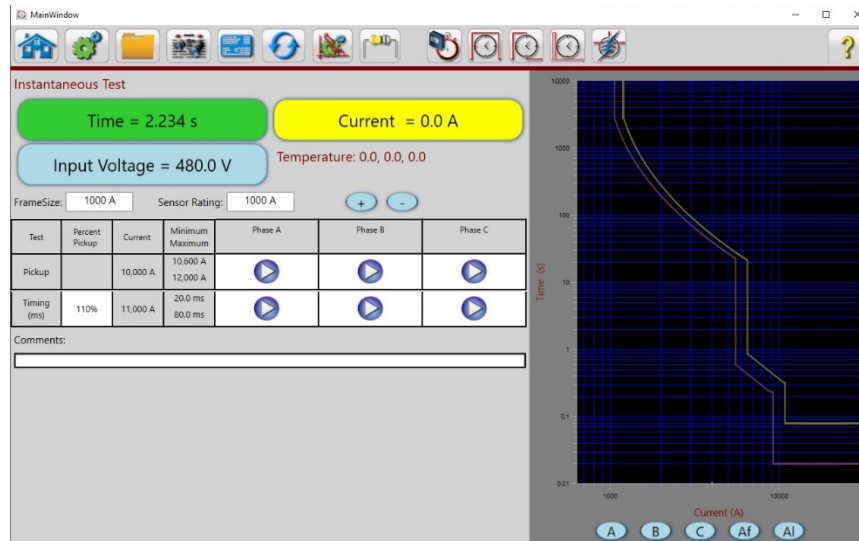

Figure 47 Instantaneous Test Screen

To perform an **Inst pickup**, press the blue play button in the **Pickup** row under the **Phase** desired to be tested. A screen will appear showing the details of the test. See figure below.

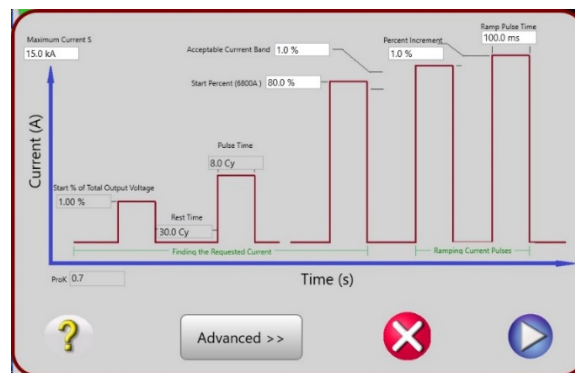

Figure 48 Instantaneous Pickup Test Description

Any of the white boxes can have the values changed by pressing the Advanced button, but in most cases the defaults are sufficient. These include:

- **Maximum Current** – Limits the test set to how high current can go during the test. This is a safety feature if desired.
- **Start% of Output** – This is the level of output (in % of transformer) that the test will start at. The unit pulses current (based on Pulse Time) and measures the amount of current applied to the output. The unit uses this feedback to approximate the desired current and applies another pulse. It will do this several times until the desired start current is reached.
- **Rest Time** – This is the rest time between search pulse.
- **Pulse Time** – This is how long the search pulse last.
- **Start Percent** – This is the percent of LT Pickup that you want to start the test at. Typically, 80% is an acceptable level to start looking for LT Pickup. The unit will do several search pulses until this level is found. Then it will start the test.
- **Acceptable Current Band** – This is the amount of error accepted when finding the starting current for the test.
- **Percent Increment** – This is the amount of current the unit will increment as the current ramps up looking for Pickup.
- **Ramp Pulse Time** – This is the amount of time the pulse will be applied. Typically, breakers trip in 3-5 cycles for Inst and the default setting is 106ms (6 cycles)

To run the test, press the blue play button and the unit will find the start current and then ramp the current up, per the settings. The unit will apply pulses long enough to trip the Inst element and keep increasing current until the breaker trips. The unit will record the trip current when the breaker trips.

To perform an **Inst Timing** test, press the blue play button in the timing row under the **Phase** that is desired to be tested. The setting screen shown in the figure below will appear.

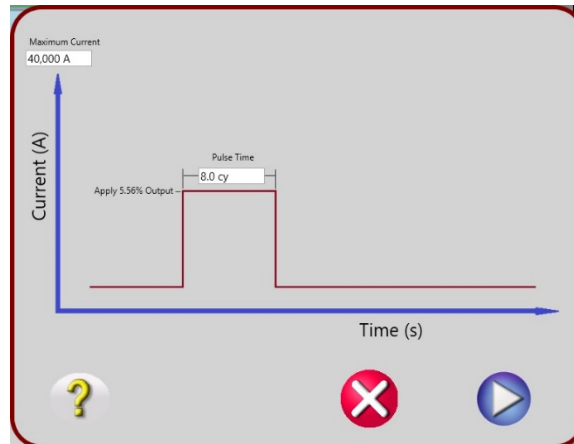

Figure 49 Instantaneous Timing Test Description

The default values in this screen will work for most tests, but any value in the white boxes can be changed. These include:

- **Maximum Current** – Limits the test set to how high current can go during the test. This can be a safety feature if desired.
- **Pulse Time** – This is how long the pulse will last. The pulse time will default to 8 cycles.

Once the settings are ready press the blue play button. The software will calculate the current needed based on the **Inst Pickup** test that was done. The test set will apply the test current. The test set will record the time it takes to trip the Inst element.

#### 4.3.3.4.4 Ground Fault Tests

There are two types of tests for Ground Fault, **Pickup** and **Timing**. The software defaults to timing at 150% of Pickup, but this can be modified to any value desired by the user. Also, additional timing tests can be added by click the “+” button next to the sensor rating. See figure below.

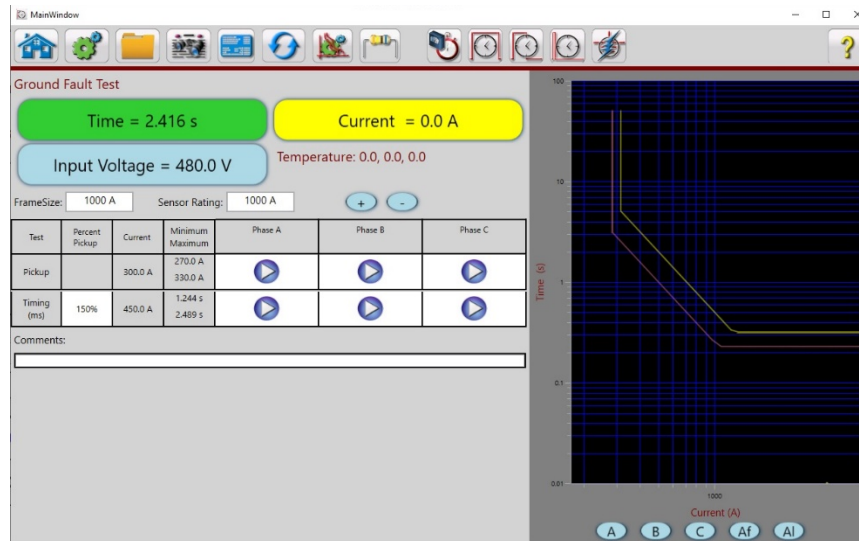

Figure 50 Ground Fault Test Screen

To perform a **Ground Fault Pickup**, press the blue play button in the **Pickup** row under the **Phase** desired to be tested. Then a screen will appear showing the details of the test. See figure below.

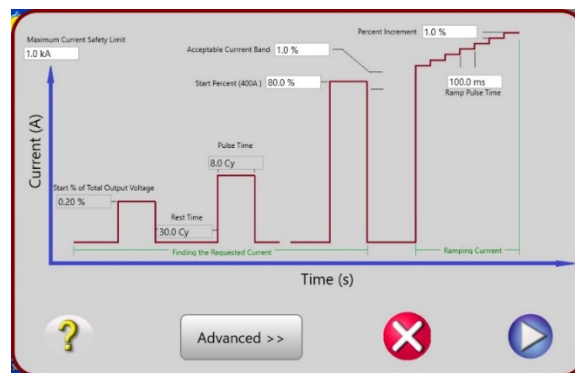

Figure 51 Ground Fault Pickup Test Description

Any of the white boxes can have the values changed by pressing the Advanced button, but in most cases the defaults are sufficient. These include:

- **Maximum Current** – Limits the test set to how high current can go during the test. This is a safety feature if desired.
- **Start% of Output** – This is the level of output (in % of transformer) that the test will start at. The unit pulses current (based on Pulse Time) and measures the amount of current applied to the output. The unit uses this feedback to approximate the desired current and applies another pulse. It will do this several times until the desired start current is reached.
- **Rest Time** – This is the rest time between search pulse.
- **Pulse Time** – This is how long the search pulse last.
- **Start Percent** – This is the percent of LT Pickup that you want to start the test at. Typically, 80% is an acceptable level to start looking for LT Pickup. The unit will do several search pulses until this level is found. Then it will start the test.
- **Acceptable Current Band** – This is the amount of error accepted when finding the starting current for the test.
- **Percent Increment** – This is the amount of current the unit will increment as the current ramps up looking for Pickup.



- **Ramp Pulse Time** – This is the amount of time the pulse will be applied. Typically, breakers trip instantaneous to 300 ms for Ground Fault.

To run the test, press the blue play button and the unit will find the start current and then ramp the current up, per the settings. The unit will apply pulses long enough to trip the Ground Fault element and keep increasing current until the breaker trips. The unit will record the trip current when the breaker trips.

To perform a **Ground Fault Timing** test, press the blue play button in the timing row under the **Phase** that is desired to be tested. The setting screen shown in the figure below will appear.

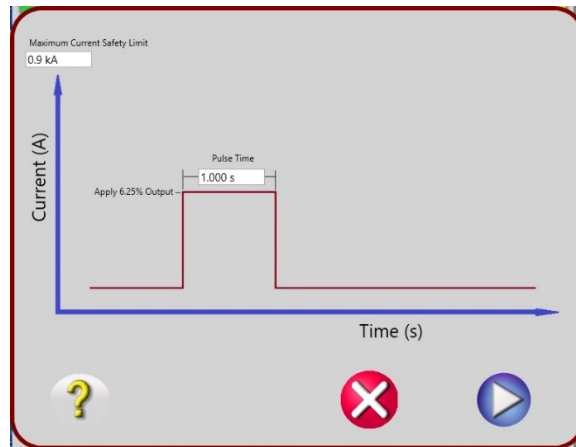

Figure 52 Ground Fault Timing Test Description

The default values in this screen will provide work for most testing, but any value in the white boxes can be changed by clicking in the window. These include:

- **Maximum Current** – Limits the test set to how high current can go during the test. This is a safety feature if desired.
- **Pulse Time** – This is how long the pulse will last. The pulse time will default to 8 cycles.

Once the settings are ready press the blue play button. The software will calculate the current needed based on the **Ground Fault Pickup** test that was done. The test set will apply the test current. The test set will record the time it takes to trip the Inst element.

If the breaker to be tested is a Molded Case breaker press the **Breaker Type Air Frame** button, and the following list will be provided.



Figure 53 Breaker Type Options

Click on **Molded Case** and the **Manufacturers Curve**, and the following Options window will appear.



Figure 54 Breaker Manufacturers List

Select from the available manufacturers. If the manufacturer for your breaker does not exist go back and use the **Generic Breaker**. NOTE: New manufacturers TCC's will be added to the software from time to time. Check with your Megger sales representative regarding additional breaker TCC's, or check the Megger website to see if a new version of software is available to download, see section 5.3 for more information.

Tests are similar to those described for the air frame breakers.

## 5.0 Manual Testing of Motor Overload Relays and Circuit Breakers

This section of the User Guide will provide examples of the testing of motor overload relays, molded case circuit breakers and low voltage power circuit breakers.

### 5.1 Manual Test of Motor Overload Relays



**APPLICATION NOTE:** Always refer to the manufacturer's literature applicable to the motor overload relay before testing. The test operator should be familiar with the operating characteristics of the relay, the tolerances applicable to the operating characteristics and any means of adjusting the relay.

The test usually performed on motor overload relays is to verify the time delay characteristics of the relay when subjected to an overload condition. One test point is usually suggested to establish whether the relay is operating correctly, and within the band of the time- current curve for the relay. The suggested test current is three times (3x) the normal current rating of thermal overload relays or three times (3x) the pick-up current (setting) of magnetic overload relays.

It is, of course, easiest to make the connections and perform the tests on the relays if they are removed from the starter. However, it is not necessary to remove the relay as long as the power circuit is *de-energized*, and the test leads can be connected to the device. The high current leads from the test set to the relay under test should be kept as short as possible and should be twisted to minimize losses caused by inductive reactance.

Run the test and note the time required for the overload relay to trip. If the tripping time exceeds the manufacturer's recommended value, or if the relay does not trip at all, the relay may not be protecting the motor properly. If the relay operates too quickly, it may result in unnecessary nuisance trips. It should be remembered that these devices

operate over a wide band and precise results should not be sought. A tolerance of  $\pm 15\%$  is usually acceptable for electromechanical devices.

If a thermal overload relay is not operating properly, tripping too soon or too late, remove the heater element. Note its type, rating, etc., and compare with manufacturer's data for operating characteristics of the motor. If correct for the application, substitute a new heater of the same rating and retest. If either under- or over-sized heater elements are being used, replace with the proper size heater and retest.

If a magnetic overload relay is not operating properly, refer to the relay manufacturer's literature for instructions on adjusting of the time delay. If the relay is operating improperly, it also may be desirable to verify the pickup point (minimum operating point) of the relay. To perform this test, it is necessary to disengage the time delay feature of the overload relay. Refer to the manufacturer's literature for detailed instructions.

### 5.1.1 Testing Time Delay

1. Connect the test set to a suitable source of power. Be sure that the **ON/OFF** Switch on the test set is **OFF**.
2. Make sure the motor circuit is de-energized.
3. Connect the output of the test set to the terminal of the heater of operating coil to be tested. (See Section 3.2.5.1, Selection of Output Connections).
4. Connect a set of light leads from the Binary Input terminals marked **EXT STOP** to the control circuit contacts of the relay being tested.
5. Turn the test set's **ON/OFF** Switch "**ON**".
6. When the Main Screen appears press the Configuration  button, and select the **System** Tab. Press the **Stop On Loss of Current** button. The following options list will appear.

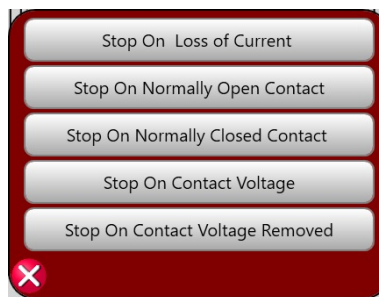



Figure 55 Timer Stop Options List

Set the Timer to Stop that is most appropriate for the device under test (See Section 3.4.1.2.2.2, **Stop On Options** and **APPLICATION NOTES** below). If using **Output Connections in Series** mode, press the **Series Mode** button to change to **Series Mode On** (see **APPLICATION NOTES** below).



**APPLICATION NOTES:** Usually Normally Open or Normally Closed contacts are used for trip. Normally, series output connections are not required for testing motor overload relays. However, if long test leads are used to connect to the device, there may be enough voltage drop that a series connection may be required.

- After configuring the Timer Stop, press the Home  button, then press on the Manual Test button . The following screen will appear.

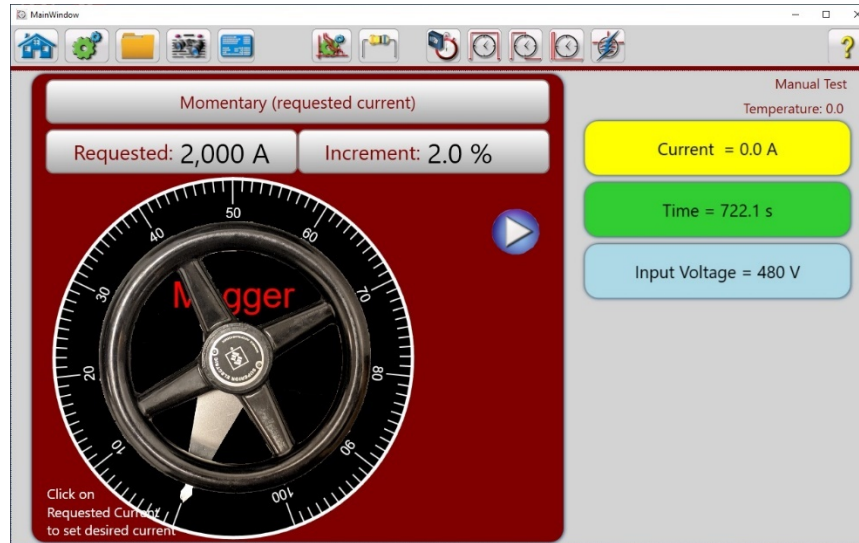

Figure 56 Manual Test Screen

- Pressing the **Momentary (requested current)** button will display the following figure.

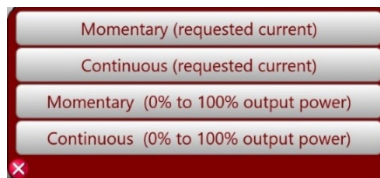

Figure 57 Manual Modes of Operation

Press the **Continuous (requested current)** button, and using the pop-up numerical keypad type in a **Requested Current** test value. If using the PC version, click in the **Requested Current** window and use the PC numeric keys to enter the desired output test current value.



**APPLICATION NOTE:** The suggested test current is three times (3x) the normal current rating of thermal overload relays, or three times (3x) the pick-up current (setting) of magnetic overload relays.

- Press the blue play button in the Manual Test Screen and the following figure will appear. Press the Advanced button, click in the white window for **Max Time**, and enter a maximum time that the test current will be applied (enter a value that is 15% greater than the expected trip time). Note that the software will automatically set a Maximum Current Safety Limit greater than the Requested Current entered by the user.



Figure 58 Continuous Requested Test Current Setting Screen



**APPLICATION NOTE:** In the above figure the **Pretest Time** defaults to 2 seconds. Depending on the requested test current, a longer cool down time may be required. Press or click in the white **Pretest Time** window to enter a longer Pretest (cool down) Time.

10. In the figure above, press the blue play button. When blue play button is pressed the unit will pulse current until the desired test current is found, then it will continuously run the requested test current until the device trips, or the **Max Time** setting, whichever comes first. The timer will stop and the output will automatically de-energize when the overload relay operates.

11. Record the results by pressing the Add to Reports  button.

## 5.2 Manual Testing of Molded Case and Low Voltage Power Circuit Breakers



**APPLICATION NOTES:** Always refer to the manufacturer's literature applicable to the circuit breaker before testing. The test operator should be familiar with the operating characteristics of the circuit breaker, the tolerances applicable to the operating characteristics, and any means for adjusting the circuit breakers.

Molded case breakers are usually tested for verification of the time delay characteristics, and the minimum operating point (pick-up point) of the instantaneous element. Low voltage power circuit breakers with solid state or electro-mechanical trip devices are usually tested for verification of the time delay characteristics of the long-time delay and short time delay elements, and for the minimum operating point (pick-up point) of the instantaneous element. Each circuit breaker pole should be tested independently so that all trip devices are tested.

One test point is usually sufficient to establish whether the long-time delay or short time delay element is operating properly and within the band width of its time-current characteristics. For molded case breakers the suggested test current of the time delay element is three times (3x) the current rating of the breaker; for low voltage power circuit breakers, suggested test current is three times (3x) the pick-up setting of the long-time delay element, and one- and one-half times (1.5x) the short time delay setting where the type of trip characteristics is incorporated on the trip device.

On both molded case and low voltage power breakers, the instantaneous element is tested to verify the minimum current necessary to cause the breaker to consistently trip instantaneously.

Typically, the instantaneous elements have an operating tolerance of from  $\pm 10\%$  to  $\pm 25\%$  of setting, depending on the trip device. On molded case circuit breakers, it is suggested that the time delay elements be tested before any instantaneous tests are performed.

Most modern low voltage power circuit breakers are of the "draw-out" type. These breakers should be tested using the SPI4000 equipped with the appropriate stabs to directly connect the breaker to the test set (see Section 8, Accessories). When testing molded case breakers or any other breaker where test cables are required to connect it to the test set, the cables should be as short as possible and twisted to minimize losses. See Section 3.2.5.1 on Selection of Output Connections.

### 5.2.1 Testing Time Delay

1. Connect the test set to a suitable source of power. Be sure that the **ON/OFF** Switch on the test set is **OFF**.
2. Make sure the line side circuit of the breaker to be tested is de-energized or disconnected. Close the breaker to be tested.
3. Connect the output of the test set to one pole of the breaker to be tested. (See Section 3.2.5.1, Selection of Output Connections).



**APPLICATION NOTE:** Normally, series output connections are not required for testing molded case circuit breakers or Low Voltage Power Circuit Breakers. However, if long test cables are used to connect to the device, there may be enough voltage drop that a series connection may be required. If series connections are required, turn the test set on and from the Main Screen press the Configuration  button, and select the **System** Tab. Press the **Series Mode** button to change to **Series Mode On**. Press the **Timer Stop On Loss of Current** button. The following options list will appear.

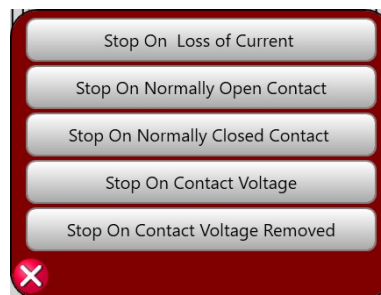

Figure 59 Timer Stop Options List

5. Set the Timer to Stop that is most appropriate for the device under test (See Section 3.4.1.2.2.2, **Stop On Options** and **APPLICATION NOTE** below).



**APPLICATION NOTE:** If desired, the **Normally Open** or **Normally Closed** selections may be used to control the Timer. If the **Stop on Normally Open** or **Normally Closed** are to be used, connect a set of light leads from the **EXT STOP** binary input terminals to another pole of the breaker under test or the desired auxiliary contact. Otherwise, use the **Stop On Loss of Current**.

6. Turn the test set's **ON/OFF** Switch "**ON**".
7. Press on the Manual Test button . The following screen will appear.

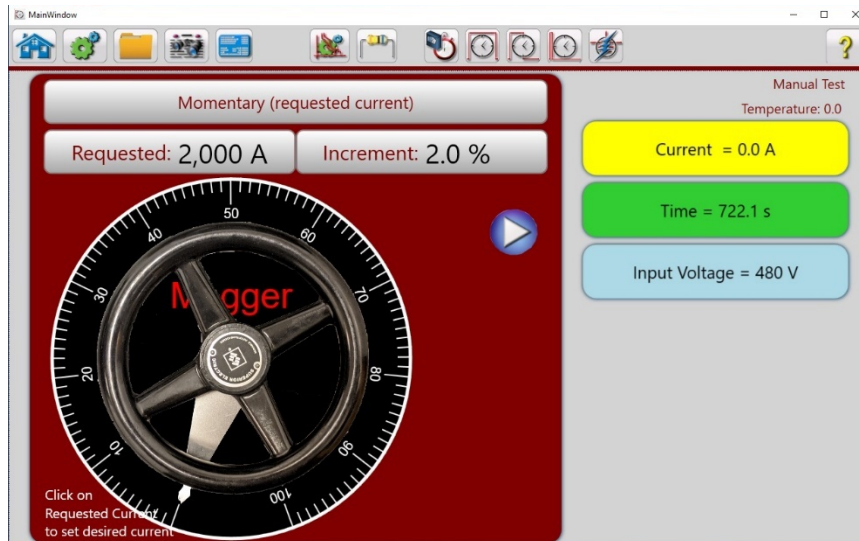

Figure 60 Manual Test Screen

- Pressing the **Momentary (requested current)** button will display the following figure.

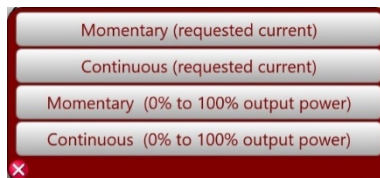

Figure 61 Manual Modes of Operation

Press the **Continuous (requested current)** button, and using the pop-up numerical keypad type in a **Requested Current** test value. If using the PC version, click in the **Requested Current** window and use the PC numeric keys to enter the desired output test current value.



**APPLICATION NOTE:** For molded case breakers the suggested test current for the time delay element is three times (3x) the normal current rating, or three times (3x) the pick-up setting of the long-time delay element, and one- and one-half times (1.5x) the short time delay setting where the type of trip characteristics is incorporated on the trip device.

- Press the blue play button in the Manual Test Screen and the following figure will appear. Press or click in the white window for **Max Time** and enter a maximum time that the test current will be applied (enter a value that is at least 15% greater than the expected trip time). Note that the software will automatically set a **Maximum Current Safety Limit** greater than the **Requested Current** entered by the user.



**APPLICATION NOTE:** For Low Voltage Power Circuit Breakers when testing the short time delay setting, set the **Max Time** to a value slightly great than the Short Time setting.



Figure 62 Continuous Requested Test Current Setting Screen

8. In the figure above, press the blue play button. When blue play button is pressed the unit will pulse current until the desired test current is found, then it will continuously run the requested test current until the device trips, or the **Max Time** setting, whichever comes first. The timer will stop and the output will automatically de-energize when the breaker operates.

9. Record the results by pressing the Add to Reports  button.

### 5.2.2 Testing Instantaneous Trip

1. Connect the test set to a suitable source of power. Be sure that the **ON/OFF** Switch on the test set is **OFF**.
2. Make sure the line side circuit of the breaker to be tested is de-energized or disconnected. Close the breaker to be tested.
3. Connect the output of the test set to one pole of the breaker to be tested. (See Section 3.2.5.1, Selection of Output Connections).



**APPLICATION NOTE:** Normally, series output connections are not required for testing molded case circuit breakers or Low Voltage Power Circuit Breakers. However, if long test cables are used to connect to the device, there may be enough voltage drop that a series connection may be required. If series connections are required, turn the test set on and from the Main Screen

press the Configuration  button, and select the **System** Tab. Press the **Series Mode** button to change to **Series Mode On**. Press the **Timer Stop On Loss of Current** button. The following options list will appear.

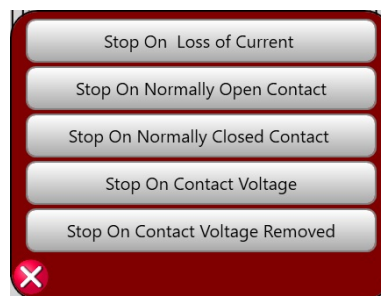

Figure 63 Timer Stop Options List

4. Set the Timer to Stop that is most appropriate for the device under test (See Section 3.4.1.2.2.2, **Stop On Options** and **APPLICATION NOTE** below).





**APPLICATION NOTE:** If desired, the **Normally Open** or **Normally Closed** selections may be used to control the Timer. If the **Stop on Normally Open** or **Normally Closed** are to be used, connect a set of light leads from the **EXT STOP** binary input terminals to another pole of the breaker under test or the desired auxiliary contact. Otherwise, use the **Stop On Loss of Current**.

5. Turn the test set's **ON/OFF** Switch "ON".
6. Press on the Manual Test button . The following screen will appear.



Figure 64 Manual Test Screen

7. Pressing the blue play  in the **Momentary (requested current)** window will display the following figure.

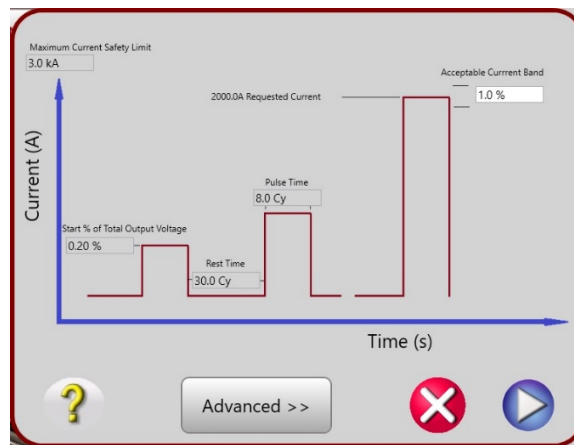



Figure 65 Momentary Requested Current Pulse Input Screen





**APPLICATION NOTE:** The graphic display above shows the user the % of Output current based upon the position of the "wheel" and the **Maximum Current Safety Limit** level will be automatically set to a value greater than the **Requested Current** entered by the user. This value can be changed to any value less than the Maximum Output Current of the SPI4000 by pressing the **Advanced** button and then the white **Maximum Current Safety Limit** window. Make sure that the

Maximum Current entered is greater than the Instantaneous Trip Setting value by at least +10% but no greater than +25%. The **Pulse Time** that the current will be applied defaults to 8.0 Cycles, but can be changed by the user by pressing the white **Pulse Time** window and enter an appropriate pulse time value. Make sure that the Pulse Time is greater than the Instantaneous Trip Time setting. For example, with the control wheel adjusted to 10 % of the **Maximum Output** setting, the expected test current should be 4,000 Amps. For **Instantaneous Pickup** it is recommended to start the current at 10% less the Pickup Setting.

8. Pressing the blue play  button in the Momentary Pulse Input Screen will produce the 8 cycles of test current. The output current will be displayed in the **Current** window. Once current is produced the user can use the up  arrow to bump the current up until the circuit breaker trips instantaneously.



**APPLICATION NOTE:** Note that the default increment of the current using the up/down arrows is 2.0%. Press the **Increment Percent** button and a numerical keypad will appear (on the STVI) to enter a higher or lower % value for finer adjustment.

9. Record the results by pressing the Add to Reports  button. To delete the test result press the eraser  button.

## 6.0 Maintenance

NOTE: There are no user replaceable parts within this product.

### 6.1 General Maintenance

Ensure the unit is kept clean and dry after use. Test cables and adaptors should be checked before use for damage and continuity.

The unit utilizes surface mount technology (SMT) and other components which require little or no service. The unit should be serviced in a clean atmosphere away from energized electrical circuits.

### 6.2 Cleaning

Never use spray liquids or industrial cleaners. Some cleaning solvents can damage electrical components, and should never be used. Remove dust with dry, low pressure, compressed air. Use a lightly damp cloth (not dripping wet) to wipe off the outer surface of the unit.

### 6.3 Updating SPI4000 Software and Firmware

#### Download Firmware Upgrade via Megger Website

##### Updating Firmware via Megger Website

To download the latest SPI4000 firmware from the Megger website,

1. Go to [WWW.Megger.com](http://WWW.Megger.com)
2. **Log In.** If you have not registered before, you will need to do so first.
3. Go to **Products / Circuit Breaker test equipment / Primary Injection test systems** and click on the picture of the SPI4000 unit.
4. Click on the **Software** tab
5. Click on the **SPI4000 Firmware #.###** **↓Download** button
6. You will see a pdf document with detailed instructions on how to update the software and firmware on the SPI4000 unit. Download the **SPI4000\_Firmware\_#.###** and install per the instructions.

**USB Memory Stick:** With the SPI4000 powered up, insert the USB memory stick into the USB type A port on top of the STVI or your PC. Press the **Configuration** Screen button, with the **General** tab highlighted press **Update System** button. At that point the user will be presented with a window that shows the Current Software version. The software will try to find the software on the USB stick. If it cannot find the software use the Browse button to search for the USB stick. When discovered the software upgrade process will automatically start. Observe the touch screen display, and the unit. At the completion of the download there will be an instruction to reboot (turn off and back on) the test system.

The rest of this page is intentionally left blank

## 7.0 Specifications<sup>2</sup>

### Input

Model	Input Voltage	Input Current	Input Frequency
SPI4000	480V +/- 5%	225 A	60 Hz

The unit will produce maximum rated output, when the input is as specified in the above table. The unit auto senses the input voltage and can run on any input voltage down to 260 volts, with possible limitations. The unit can run with a 240-volt input, with the 240-volt mode selected, and will produce ½ of rated output.

### Output

**Output Circuit:** The output of the test set is easily adjustable from zero to the maximum current available through the impedance of the device under test. Multiple output ranges are provided to accommodate a variety of load circuit impedances. For high impedance devices, the output can be connected in series to increase the output voltage at a reduced maximum current. The maximum current available from the test set is determined primarily by the impedance of the load circuit, and the input voltage. The duration of the available current is determined primarily by thermal conditions within the test set.

**Maximum Output Current:** The SPI4000 will produce the following outputs with a 480V input voltage.

#### DUTY CYCLES FOR SPI4000 CIRCUIT BREAKER TEST SET (Current Rating through a Circuit Breaker)

Current	Time On	Time Off
4,000 A	Continuous	N/A
4,500 A	30 Min	30 Min
6,000 A	15 Min	45 Min
15,000 A	2 Min	60 Min
40,000 A	2.5 Sec	12 Min

**Output Connections:** To provide maximum utilization of the output available from the test set, each set is equipped with a Megger stab adapter board and stab sets Model CBS-1 and Model CBS-2 for use with draw-out style, metal-clad breakers. The stabs eliminate the significant losses that occur if leads are used to connect the breaker under test to the test set. Cables must be used when testing molded-case breakers or other devices which will not connect directly to the stabs. Cables must be used when testing molded-case breakers or other devices that will not connect directly to the stabs.

### Instrumentation<sup>3</sup>

#### Digital Ammeter

##### Operating Mode

Memory

Continuous

**Digital Display:** Auto-ranging display with large numerals

**Ranges:** 400 / 4,000 / 40,000 A

##### Overall Ammeter System Accuracy

###### 400-amp Scale:

Continuous  $\pm 1\%$  of reading  $\pm 1\%$  of Range

RMS Pulse  $\pm 1.5\%$  of Range

<sup>2</sup> Megger reserves the right to change product specifications at any time without notice.

<sup>2</sup> Accuracies specified within  $23^\circ \pm 5^\circ$  C ( $73^\circ \pm 9^\circ$  F) in the frequency range of 45 to 65 Hz, and after warm-up of 20 min.

<sup>3</sup> Accuracies specified within  $23^\circ \pm 5^\circ$  C ( $73^\circ \pm 9^\circ$  F), and after warm-up of 20 min.

Peak Pulse  $\pm 2.0\%$  of Range

**4,000/40,000-amp Scale:**

Continuous  $\pm 1\%$  of reading  $\pm 0.1\%$  of Range

RMS Pulse  $\pm 1.5\%$  of reading  $\pm 0.1\%$  of Range

Peak Pulse  $\pm 2.0\%$  of reading  $\pm 0.1\%$  of Range

**Digital Timer**

**Digital Display:** Auto-ranging display with large numerals

**Ranges**

0.1-999.9 mS

1.00 to 99999 seconds

0.1 to 99999 cycles

**Accuracy:**  $\pm 1\%$  of reading  $\pm 2\text{mS}$

**Digital Voltmeter**

**Operating Mode**

Input voltage

External voltage (future)

**Ranges:** 0.0010 to 600.0 V

**Accuracy:**  $\pm 1\%$  of reading  $\pm 1$  LSD

**Data input/output**

**Ethernet:** 1 Port 10/100Mbit PC or STVI/POE connection

**Dimensions**

31" H X 34" W X 21" D

78.8 H X 86.4 W X 53.5 D (cm)

**Weight**

514 lbs.

233 kg

**Environmental**

**Operating Temperature**

0° to 50° C

**Storage Temperature**

-30° to 70° C

**Humidity**

IEC 60068-2-30

0 to 90% non-Condensing

**Conformance Standards**

**Safety:** EN 61010-1, CSA

**Shock:** ISTA 1H Sequence #3

**Vibration:** ISTA 1H Sequence #2

**Emissions:** EN 61326-2-1, EN 61000-3-2/3,

FCC Subpart B of Part 15 Class A

**Immunity:** EN 61000-4-2/3/4/5/6/8/11

8.0 **Accessories**





8.1 **Included accessories**

Included Standard Accessories	Part Number
-------------------------------	-------------

Standard Stab Sets	<b>CBS-1 and CBS-2</b>
Stab Adaptor Set (allows for use of standard stab sets)	<b>V1015-563 &amp; V1015-564</b>
Input Leads, 15 ft. (4.5m) 4/0 cable, 2 ea.	<b>2016-714</b>
Series Stab Bar, Used to connect the output stabs in Series	2016-672

## 8.2 Optional accessories

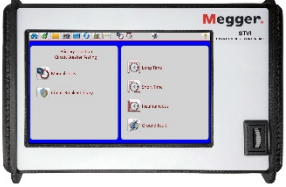
Additional Optional Test Leads and Accessories can be ordered individually, see description and part numbers below. **The following accessories and part numbers are in quantities of 1 each. Order the appropriate number required.**

	<b>Descriptions of Additional Optional Test Leads and Accessories</b>	<b>Part Number</b>
	Ground Cam-lock Adapter, 15 ft. (4.5m) #2 AWG cable	<b>1015-592</b>
	CBS-FLEX Adapter Used to connect the output stabs to virtually any air frame breaker.	<b>CBS-FLEX-Kit</b>
	Breakers that require a set of stabs designed specifically for that breaker can be accommodated by Model CBS-3 stab sets. The most common breakers requiring Model CBS-3 stabs are listed in the CBS-1, CBS-2 and CBS-3 Datasheet Ordering Information.	
	Smart Touch View Interface Hand Held Controller for SPI4000	<b>STVI-10</b>
	<b>Sleeved pair of test leads:</b> Red and black sleeved leads with retractable safety shrouds, use with timer, or binary I/O, 200 cm long (78.7") 600 V/ 32 Amps CAT II, RoHS compliant.	<b>2008-539-2</b>

	<p><b>Alligator/Crocodile Clip:</b> Excellent for test connections to terminal screws and pins where spade lugs cannot be used.</p> <p>Alligator clip, <b>red</b>, use with test leads up to 1000 V CAT III /32 Amps.</p> <p>Alligator clip, <b>black</b>, use with test leads up to 1000 V CAT III /32 Amps.</p>	<p><b>684006</b></p> <p><b>684007</b></p>
-----------------------------------------------------------------------------------	-------------------------------------------------------------------------------------------------------------------------------------------------------------------------------------------------------------------------------------------------------------------------------------------------------------------	-------------------------------------------

## 9.0 Calibration, Repair and Warranty

Megger operates fully traceable calibration and repair facilities to make sure your instrument continues to provide the high standard of performance and workmanship that is expected. These facilities are complemented by a worldwide network of approved repair and calibration companies, which offer excellent in-service care for your Megger products.

Since the SPI4000 uses Surface Mount Technology, repairs are beyond the basic capabilities of the majority of customers, and should be referred to the Service Department at Megger or handled through the Megger Representative.

For calibration and service requirements for Megger SPI4000 instruments contact:

Megger  
4545 W Davis Street  
Dallas, Texas 75211-3422 USA.  
PHONE: 1-214-330-3519  
FAX: 1-214-331-7399

**!** If the unit is still within the original warranty period, or limited warranty period following factory servicing, **the factory must be contacted before attempting any repairs or the warranty will be void.**



## 9.1 Warranty

Megger warrants the equipment sold by Megger, or our authorized agents, to be free from defects in material and workmanship, reasonable wear and tear excluded, for a period of 12 months from date of shipment. Since Megger has no control over conditions of use, no warranty is made or implied as to suitability for customer's intended use beyond the units normal performance specifications. No other warranty is either expressed or implied. Megger shall not be liable for consequential damages.

Warranty service will be performed on the equipment at the Megger factory. The customer shall prepay shipping charges for units returned to Megger. Megger shall pay for the return of the repaired or replaced unit to the customer (repair or replace at Megger's option), provided that the Instrument has not been altered, modified or repaired by unauthorized personnel, and that our examination discloses to our satisfaction that any improper operation or failure was not the result of improper use, negligence or accident, exceeding environmental limits, or connecting the Instrument to incompatible equipment. The customer is asked to obtain a return authorization number from Megger PRIOR TO returning a unit for service, see Return Procedure.

## 9.2 Return Procedure

1. When an instrument requires recalibration, calibration certification, or in the event of a repair being necessary, a Return Authorization (RA) number must first be obtained from the address shown above. The following information is to be provided to enable the Service Department to prepare in advance for receipt of your instrument and to provide the best possible service to you:

- Model number, SPI4000.
  - Serial number (found on the display under Configuration, System tab, or on the unit enclosure, or on the calibration certificate).
  - Reason for return (for example, calibration required, or repair).
  - Details of the problem if the instrument is to be repaired.
  - Provide a return address, your name, and how to contact you should the factory need to discuss the service request.
2. Make a note of the RA number. A return label can be emailed or faxed to you if required.
-  Save the original shipping container for future use. The shipping container is designed to withstand the rigors of shipping via a common commercial carrier. For example, you may wish to reship your unit to Megger for an annual calibration recertification.
3. Pack the equipment appropriately to prevent damage during shipment. If a reusable container is utilized, the unit will be returned in the same shipping container if it is in suitable condition.
-  **NOTE:** Ship the equipment without nonessential items such as test cables, etc. These items are not needed by the factory to perform service.
4. Before the instrument is sent to Megger, freight prepaid, make sure that the return label is attached or that the RA number is clearly marked on the outside of the package, and on any correspondence. Copies of the original purchase invoice and packing note should be sent simultaneously by airmail to expedite clearance through customs. In the case of instruments which require repair outside the warranty period, an immediate quotation can be provided when obtaining the RA number.
5. Track the progress on line at [www.megger.com](http://www.megger.com)

### 9.3 Lifting and Transporting

Lifting and transporting the unit is necessary to move the unit to and from the job site. The following are brief descriptions and recommendations for moving the unit.

#### 9.3.1 Lifting

The weight of the SPI4000, *without accessories*, is 514 lbs. or 233 kg. The cube measurement of the unit is 12.8 ft<sup>3</sup> or 0.3625 m<sup>3</sup>. Lifting the unit will require an appropriate lifting device, such as a forklift. If using a forklift, the unit comes with 4 lifting pintles (one on each corner), see the following figure. These pintles are designed to properly lift the unit, as well as secure the unit as tie-down points during transportation.



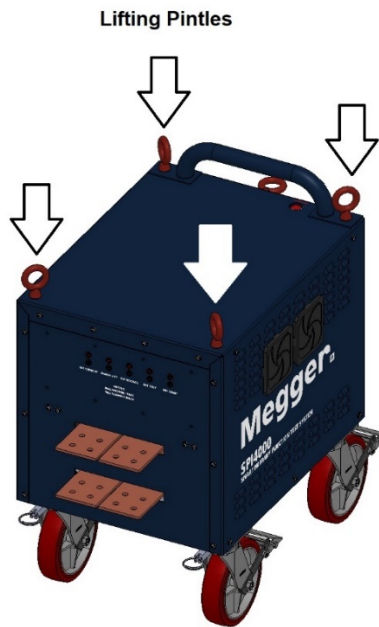

 **CAUTION:** The lifting pintles are designed to securely hold the weight of the unit with an appropriate lifting device. Using any other means of lifting the unit could cause damage to the unit.

### 9.3.2 Transporting

The unit comes with 4 locking swivel casters for rolling the unit around the job site, or onto an appropriate means of transportation, such as a heavy-duty truck with a loading ramp. The casters can be locked in place to help keep the unit from moving while stationary. Optional - pneumatic wheels with swivel castors on front and stationery on rear.

 **CAUTION:** Use the lifting pintles as tie-down points to secure the unit when transporting. Use the locking feature of the casters to provide additional support to prevent the unit from shifting during transport.

## 10.0 Decommissioning

### 10.1 WEEE Directive



The crossed out wheeled waste bin placed on Megger products is a reminder not to dispose of the product at the end of its life with general waste. Please utilize your local WEEE collection facilities, or observe all applicable local requirements.

Megger is registered in the UK as a Producer of Electrical and Electronic Equipment. The Registration No is WEE/HE0146QT.

For further information about disposal of the product consult your local Megger company representative or distributor, or visit your local Megger website.